

MENABO

free time on the move

Get ready and leave with us for new adventures

EXTRAORDINARY



MENABO
free time on the move

Esplora
il mondo
insieme a
noi



Explore
the
world
with
us

L'azienda | The company

Menabo è il marchio italiano conosciuto e apprezzato per il suo design caratteristico e alti standard qualitativi.

Da oltre 50 anni la nostra azienda produce una vasta gamma di barre da tetto, portabici, bauli da tetto e portasci, tutti certificati secondo le più rigide norme di sicurezza.

I nostri obiettivi: innovazione, sicurezza e qualità.

Menabo is the Italian brand known and appreciated for its distinctive design and high quality standards. For over 50 years we have been manufacturing a wide range of car racks such as roof racks, roof boxes, bike racks, and ski racks, all certified in accordance with the strictest safety standards.

Our goals: innovation, safety and quality.

La nostra missione | Our mission

Tutti dovrebbero avere la possibilità di acquistare accessori auto con il massimo livello di sicurezza e al prezzo migliore.

La nostra missione è quella di progettare, testare e produrre questo tipo di prodotti.

La scala di valori Menabo è sempre focalizzata su 3 principali elementi:

- Sicurezza
- Qualità
- Performance

Everybody should have the possibility to buy car accessories with the maximum level of safety at the right price.

Our mission is to design, to test and to manufacture this kind of products.

The Menabo hierarchy of values is always focused on three main values:

- Safety
- Quality
- Performance

Contenuti | Contents

06	Barre da tetto Roof racks Barre da tetto per auto con rails / Roof racks for cars with rails Barre da tetto per auto senza rails / Roof racks for cars without rails Barre da tetto OE / OE roof racks Barre da tetto per auto con grondina/ Roof racks for cars with rain gutter
22	Accessori per pickup Pickup accessories
24	Accessori per carrelli rimorchi Trailers accessories
25	Accessori per Van e Caravan Van and Caravan accessories
28	Portabici Bike racks Portabici da tetto / Roof bike racks Portabici da gancio traino / Towbar bike racks Portabici posteriori / Trunk bike racks Accessori per portabici / Bike racks accessories
50	Bauli e portapacchi Roof boxes and baskets
72	Portasci Ski racks
82	Sport acquatici Water sports
86	Borse e zaini Bags and backpacks
92	Organizzazione del garage Garage hardware
96	Accessori per veicoli commerciali Commercial vehicles accessories



BARRE DA TETTO

ROOF RACKS

Scopri le soluzioni perfette per il fissaggio di attrezzature sportive come portasci, portabiciclette e box da tetto.

Vasta gamma di modelli per la tua auto.

Discover the perfect solutions to fix your sport equipment such as ski racks, bike racks and roof boxes.

Wide range of models for your cars.



ROOF RACKS OVERVIEW



Barre da tetto per auto senza rails
Roof racks for cars without rails

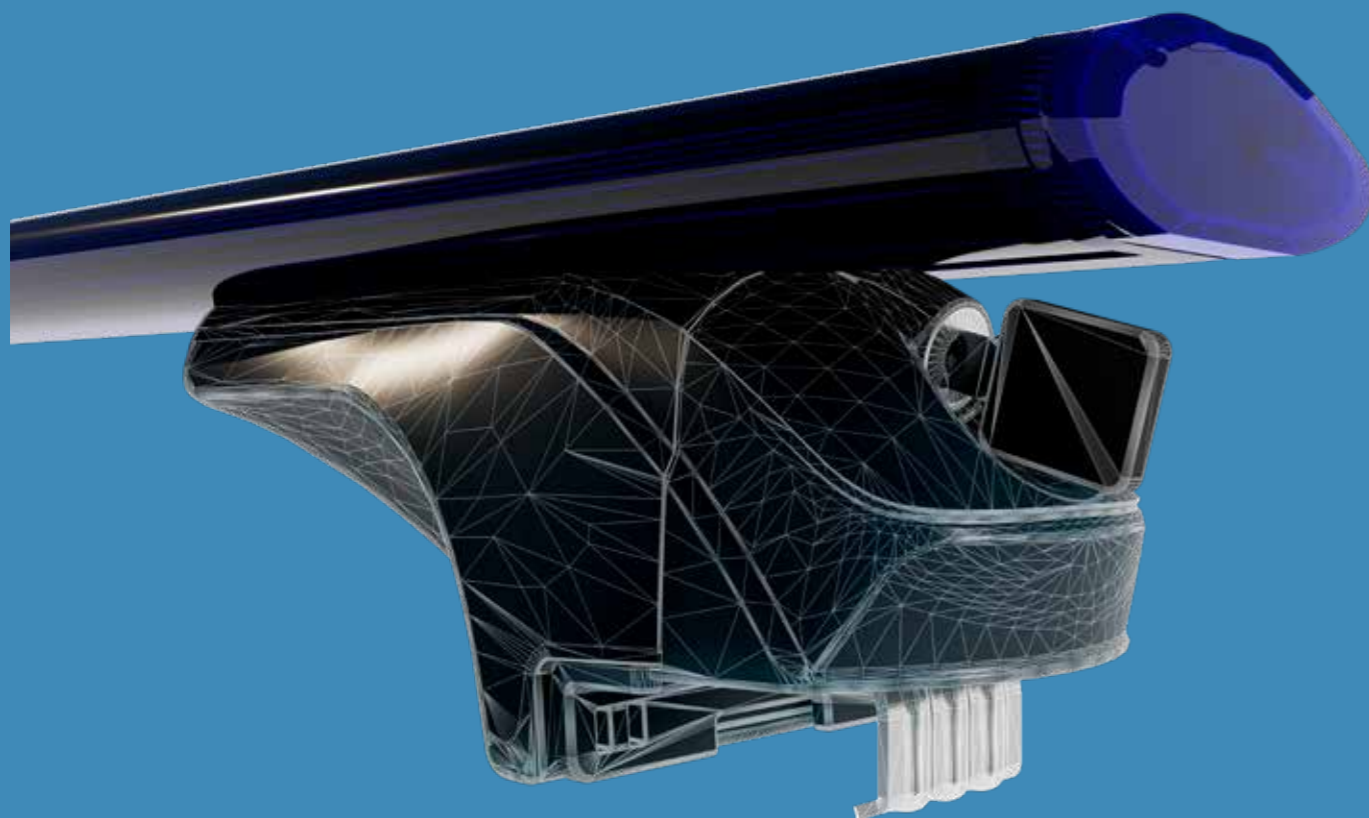

Barre da tetto per auto con rails
Roof racks for cars with rails



Scansiona il codice per verificare i modelli compatibili con la tua auto.

Scan the code to check which models are compatible with your car.

Barre da tetto preassemblate per veicoli con rails.
Disponibili in diversi modelli e lunghezze per garantire la compatibilità con un'ampia gamma di auto.

Pre-assembled roof racks for vehicles with rails.
Available in different models and lengths to ensure compatibility with a wide range of cars.



Tetti auto compatibili
Compatible car roofs

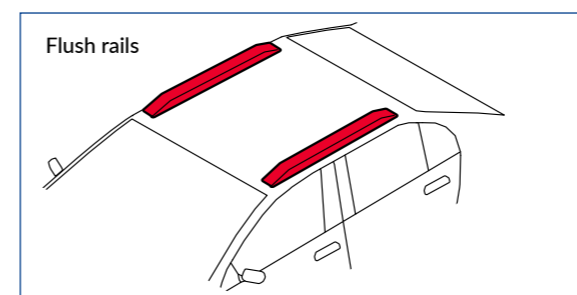

Barre longitudinali integrate al tetto.
Longitudinal bars integrated into the roof.

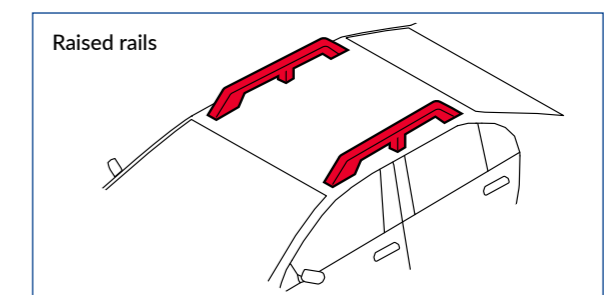

Barre longitudinali alte.
Longitudinal raised rails.

LINCE

Silver



Barre da tetto in alluminio di qualità con profilo largo e piatto per una migliore aerodinamicità e silenziosità. Provviste di scanalatura per il montaggio rapido degli accessori tramite viti a "T". Dotate di serratura antifurto. Disponibili in 2 lunghezze.

High quality aluminium roof bars with wide and flat profile, for improved aerodynamics and reduced wind noise. Provided with groove for quick mounting of accessories by means of "T" screws. Equipped with anti-theft lock. Available in 2 lengths.

Flush rails only



Optional 000110100000

Lince silver
Lince XL silver

Art.000088900000
Art.000088800000



ARIEM

Silver



Barre da tetto in alluminio di qualità con profilo anodizzato silver. Provviste di scanalatura per il montaggio rapido degli accessori tramite viti a "T". Dotate di serratura antifurto. Disponibili in 2 lunghezze.

High quality aluminium roof bars with silver anodized profile. Provided with groove for quick mounting of accessories by means of "T" screws. Equipped with anti-theft lock. Available in 2 lengths.

Flush rails



Raised rails

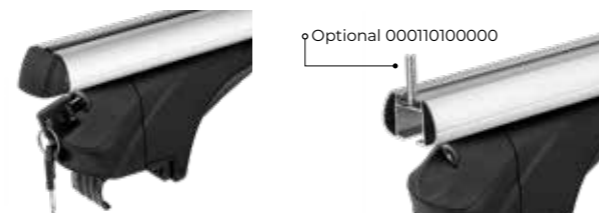

Optional 000110100000

Ariem silver
Ariem XL silver

Art.000147000000
Art.000147100000



FENDER

Black



Barre da tetto in alluminio di qualità con profilo ad ala per una migliore aerodinamicità e silenziosità. Provviste di scanalatura per il montaggio rapido degli accessori tramite viti a "T". Dotate di serratura antifurto. Disponibili in 2 lunghezze.

High quality aluminium roof bars with wing-profile, for improved aerodynamics and reduced wind noise. Provided with groove for quick mounting of accessories by means of "T" screws. Equipped with anti-theft lock. Available in 2 lengths.

Raised rails only



Optional 000110100000

Fender black
Fender XL Black

Art.000146600000
Art.000146700000



SHERMAN



Silver

Black



COMPLIANT WITH
DIN 75302:2019

TESTED
CITY CRASH

COMPLIANT WITH
ISO/PAS
11154:2006

Barre da tetto dall'ottimo rapporto qualità-prezzo, con profilo in alluminio, provviste di scanalatura per il montaggio rapido degli accessori tramite viti a "T". Dotate di serratura antifurto. Disponibili in 2 lunghezze e nelle versioni black o silver.

Aluminium roof bars, at the best value for money, with perfect quality-price ratio. Provided with groove for quick mounting of accessories by means of "T" screws. Equipped with anti-theft lock. Available in 2 lengths and colours.

Raised rails only



Optional 000110100000

Sherman silver
Sherman XL silver
Sherman black
Sherman XL black

Art.000095900000
Art.000094700000
Art.000122800000
Art.000122900000



TIGER



COMPLIANT WITH
DIN 75302:2019

TESTED
CITY CRASH ✓

COMPLIANT WITH
ISO/PAS
11154:2006

Barre da tetto in alluminio con profili anodizzati silver o black. Provviste di scanalatura per il montaggio rapido degli accessori tramite viti a "T". Serratura antifurto di serie nella versione silver, opzionale nella versione black. Disponibili in 2 lunghezze.

Roof bars with silver or black anodized aluminium profile. Provided with groove for quick mounting of accessories by means of "T" screws. Anti-theft lock as standard is included in the silver version. Available in 2 lengths.

Flush rails

Raised rails



Tiger Silver

Optional 000110100000

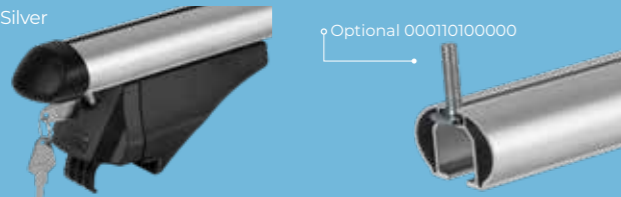

Tiger Black
anti-theft
optional kit
000084800000



Tiger silver
Tiger XL silver
Tiger black
Tiger XL black

Art.000084900000
Art.000085000000
Art.000085900000
Art.000086000000



SONIC

Black



Barre da tetto in alluminio di qualità con profilo ad ala per una migliore aerodinamicità e silenziosità. Provviste di scanalatura per il montaggio rapido degli accessori tramite viti a "T". Dotate di serratura antifurto. Disponibili in 2 lunghezze.

High quality aluminium roof bars with wing-profile, for improved aerodynamics and reduced wind noise. Provided with groove for quick mounting of accessories by means of "T" screws. Equipped with anti-theft lock. Available in 2 lengths.

Flush rails

Raised rails



Optional 000110100000

Sonic black
Sonic XL Black

Art.000146800000
Art.000146900000



Explore
nature
with
us



Barre da tetto per auto senza rails Roof racks for cars without rails

Sistema componibile di barre portatutto per veicoli senza rails. Grazie ai molteplici kit di fissaggio e alle varianti di profili, si ha una soluzione per ogni veicolo.

Modular system of roof bars for vehicles without rails. Thanks to the wide range of fixing kits and profile lengths, there is a solution for every vehicle.

Tetti auto compatibili Compatible car roofs

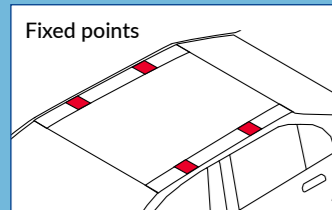

4 punti di fissaggio predisposti coperti da cover o sportelli in plastica.
Roof equipped with 4 fixed points usually covered by plastic caps.

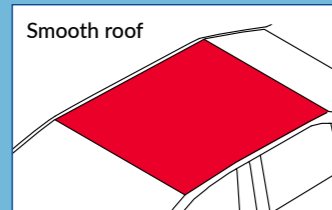

Tetto liscio senza punti di fissaggio predisposti.
Smooth roof without fixing points.

Main Kit

Coppia di profili in acciaio zincato rivestiti con guaina in PVC antiscivolo e antigraffio (Omega black). Disponibile in versione alluminio con scanalatura per il montaggio rapido degli accessori con scanalatura a "T" (Omega alu) o in alluminio con profilo ad ala (Omega plus). Completa di piedi regolabili con chiusura antifurto opzionale.

Pair of galvanized steel profiles covered with non-slip and scratch-proof PVC cover (Omega black). Also available in aluminium with T-nut (Omega alu) or in aluminium with wing-profile (Omega plus). Complete with adjustable feet with optional anti-theft lock.



Omega black

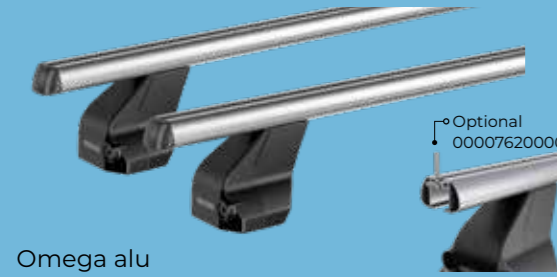

Omega alu



Omega plus

OMEGA



Main kit

COMPLIANT WITH
DIN 75302:2019

COMPLIANT WITH
ISO/PAS 1154:2006

TESTED
CITY CRASH

Fixing kit

Fixing Kit

TYPE G

Kit composto da ganasce in acciaio rivestite di plastica gommata anti-graffio e basi di supporto in gomma.
Portata massima : 50kg / 110lb.

Fixing kit including : steel clamps with scratch resistant plastic coating, rubber support pads.
Max load : 50kg / 110lb.

TYPE FP

Kit composto da supporti in acciaio che si fissano direttamente ai punti predisposti del tetto del veicolo.
Portata massima: 75kg / 165lb.

Fixing kit including : Steel brackets to be fixed directly on the roof through its fixed points.
Max load : 75kg / 165lb.



Scansiona il codice per verificare che il prodotto sia compatibile con la tua auto.
Scan the code to verify if the product is compatible with your car.



Optional kit
000084800000

Omega black M + feet kit
Omega black L + feet kit
Omega black XL + feet kit
Omega alu M + feet kit
Omega alu L + feet kit
Omega alu XL + feet kit
Omega plus silver M + feet kit
Omega plus silver L + feet kit
Omega plus silver XL + feet kit

Art.000126700000
Art.000126800000
Art.000126900000
Art.000134600000
Art.000134700000
Art.000134800000
Art.000147200000
Art.000147300000
Art.000147400000



DELTA

Barre da tetto per auto senza rails Roof racks for cars without rails

Sistema componibile di barre portatutto per veicoli senza rails. Grazie ai molteplici kit di fissaggio e alle varianti di profili, si ha una soluzione per ogni veicolo.

Modular system of roof bars for vehicles without rails. Thanks to the wide range of fixing kits and profile lengths, there is a solution for every vehicle.

Tetti auto compatibili Compatible car roofs

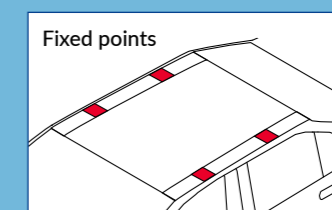

4 punti di fissaggio predisposti coperti da cover o sportelli in plastica.
Roof equipped with 4 fixed points usually covered by plastic caps.

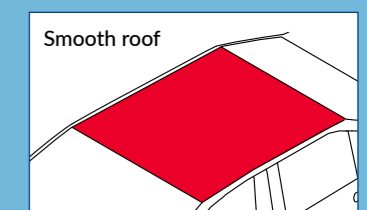

Tetto liscio senza punti di fissaggio predisposti.
Smooth roof without fixing points.



Main kit

COMPLIANT WITH
DIN 75302:2019

COMPLIANT WITH
ISO/PAS 1154:2006

TESTED
CITY CRASH

Fixing kit

Main Kit

Coppia di profili in alluminio provvisti di scanalatura per il montaggio rapido degli accessori con vite a "T". Completa di piedi d'aggancio regolabili con chiusura antifurto opzionale.

Pair of aluminium profiles with groove for quick mounting of accessories with "T" screw. Complete with adjustable hooking feet with optional anti-theft lock.



Silver



Black

Fixing Kit

TYPE G

Kit composto da ganasce in acciaio rivestite di plastica gommata anti-graffio e basi di supporto in gomma.
Portata massima : 50kg / 110lb.

Fixing kit including : steel clamps with scratch resistant plastic coating, rubber support pads.
Max load : 50kg / 110lb.

TYPE FP

Kit composto da supporti in acciaio che si fissano direttamente ai punti predisposti del tetto del veicolo.
Portata massima: 75kg / 165lb.

Fixing kit including : Steel brackets to be fixed directly on the roof through its fixed points.
Max load : 75kg / 165lb.



Scansiona il codice per verificare che il prodotto sia compatibile con la tua auto.
Scan the code to verify if the product is compatible with your car.



Optional kit
000084800000

Delta M silver + feet kit
Delta L silver + feet kit
Delta XL silver + feet kit
Delta M black + feet kit
Delta L black + feet kit
Delta XL black + feet kit

Art.000125100000
Art.000125300000
Art.000125500000
Art.000125000000
Art.000125200000
Art.000125400000



BARRE DA TETTO OE

OE Roof racks



Toyota Rav4 (XA50) 18 > Black
Art: 000145600000

Barre da tetto sviluppate ad hoc per modelli di auto con caratteristiche specifiche.

Roof racks designed for car models with specific features.



Optional 000110100000



Toyota Corolla (XG10) Cross 20 >
Art: 000140300000



Jeep Compass 2016 >
Art: 000139900000



VW ID Buzz 2022 >
Art: 000140600000

BARRE DA TETTO PER AUTO CON GRONDINA

Roof racks for cars with rain gutter



Barre da tetto in alluminio per auto con grondina, provviste di scanalatura per montaggio rapido di accessori tramite viti a "T".

Staffe in acciaio rivestite di plastica gommata anti-graffio complete di cover con antifurto. L'innovativo T-system consente di inserire le viti solo premendo leggermente il profilo in gomma.

Aluminium roof racks for cars with rain gutter, provided with groove for quick mounting of accessories by means of "T" screws.

Steel plates with scratch resistant plastic coating, equipped with cover and lock.

Thanks to the new T-system screws can be entered just by pushing the rubber profile.



























- Offroad 1345mm Art.000149300000
- Offroad 1425 mm Art.000149400000
- Offroad 1475 mm Art.000149500000
- Offroad 1500 mm Art.000149600000



Have fun
around
the
world

SCHEDA TECNICA BARRE DA TETTO

ROOF RACKS TECHNICAL DATASHEET

Art.			T-System	Tetti auto compatibilità Compatible vehicle roof types
LINCE	90Kg / 198lb			Flush rails
FENDER black	90Kg / 198lb			Raised rails
SHERMAN	90Kg / 198lb			Raised rails
TIGER	75Kg / 165lb			Flush rails Raised rails
SONIC black	75Kg / 165lb			Flush rails Raised rails
ARIEM silver	75Kg / 165lb			Flush rails Raised rails
OE Toyota Rav 4 (XA50) 18> black	75Kg / 165lb			Toyota Rav4 (XA50) 18> Suzuki Across 20>
OE Toyota Corolla (XG10) Cross 20>	75Kg / 165lb			Toyota Corolla Cross (XG10) 20 >
OE Jeep Compass 16>	75Kg / 165lb			Jeep Compass (MP/552) 16 >
OE VW ID Buzz 22>	75Kg / 165lb			Volkswagen ID Buzz 2022 >
OFFROAD	100Kg / 220lb			Rain gutter
DELTA	Fix G: 50Kg / 110lb Fix FP: 75Kg / 165lb	Optional 000084800000		Smooth roof Fixed points
OMEGA	Fix G: 50Kg / 110lb Fix FP: 75Kg / 165lb	Optional 000084800000	Omega Alu/Plus  Omega Black 	Smooth roof Fixed points

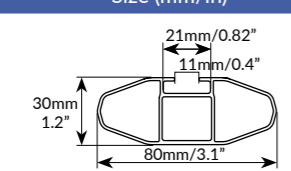
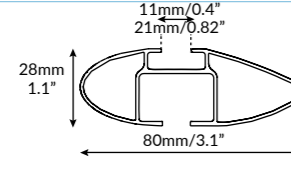
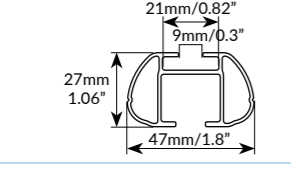
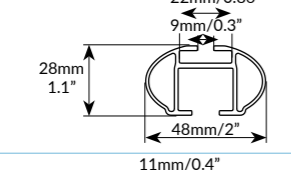
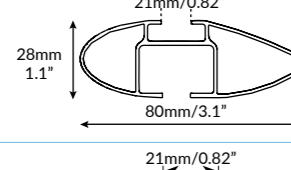
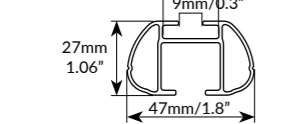
Art.	Dimensioni (mm/in) Size (mm/in)	Lunghezza (mm/in) Length (mm/in)
LINCE		Lince: 1200mm / 47.2" Lince XL: 1350mm / 53.1" Lince: min 725mm / 28.5" - max 1125mm / 44.3" Lince XL: min 865mm / 34.1" - max 1265mm / 52.7"
FENDER Black		Fender black: 1180mm / 46.5" Fender XL black: 1340mm / 52.7" Fender black: max 1090mm / 42.9" Fender XL black: max 1250mm / 49.2"
SHERMAN		Sherman silver / Sherman black: 1180mm / 46.5" Sherman XL silver / Sherman XL black: 1340mm / 52.7" Sherman silver / Sherman black: max 1090mm / 42.9" Sherman XL silver / Sherman XL black: max 1250mm / 49.2"
TIGER		Tiger silver / black: 1185mm / 46.7" Tiger XL silver / black: 1315mm / 51.8" Tiger silver / black: max 1070mm / 42.1" Tiger XL silver / black: max 1200mm / 47.2"
SONIC Black		Sonic black: 1200mm / 47.2" Sonic XL black: 1300mm / 51.2" Sonic black: min: 835mm / 32.9" - max: 1150mm / 45.3" Sonic XL black: min: 935mm / 36.8" - max: 1250mm / 49.2"
ARIEM Silver		Ariem silver: 1185mm / 46.7" Ariem XL silver: 1315mm / 51.8" Ariem silver: max 1070mm / 42.1" Ariem XL silver: max 1200mm / 47.2"

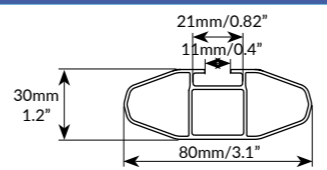
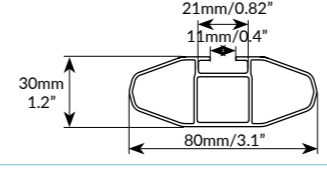
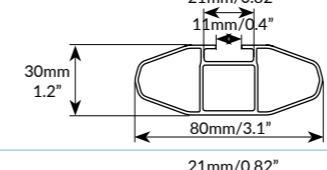
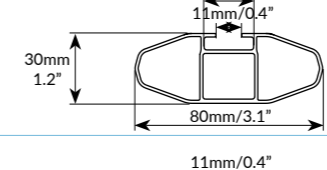
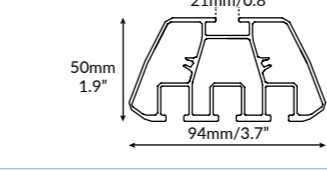
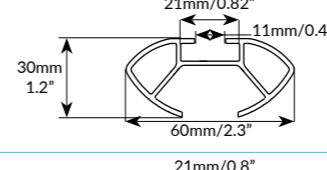
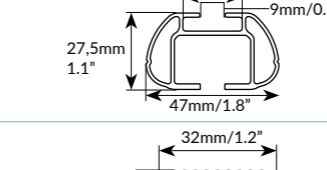
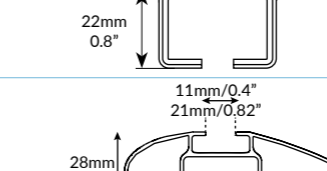
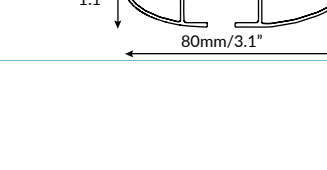
Art.	Dimensioni (mm/in) Size (mm/in)	Lunghezza (mm/in) Length (mm/in)
OE Toyota Rav 4 (XA50) 18> black		Front: 1170mm / 46.1" Rear: 1035mm / 40.7" Front: 1110mm / 43.7" Rear: 965mm / 38"
OE Toyota Corolla (XG10) Cross 20>		1200mm / 47.2"
OE Jeep Compass 16>		1200mm / 47.2"
OE VW ID Buzz 22>		1340mm / 52.7"
RAIN GUTTER		1345 mm / 52.9" 1425 mm / 56.1" 1475 mm / 58.1" 1500 mm / 59"
DELTA		Delta M: 1230mm / 48.4" Delta L: 1410mm / 55.5" Delta XL: 1610mm / 63.4"
OMEGA Alu		M: 1120mm / 44" L: 1300mm / 51" XL: 1500mm / 59" M: 664mm / 26" L: 844mm / 33.2" XL: 1044mm / 41" 228mm/9"
OMEGA Black		M: 1120mm / 44" L: 1300mm / 51" XL: 1500mm / 59" M: 664mm / 26" L: 844mm / 33.2" XL: 1044mm / 41" 228mm/9"
OMEGA Plus		M: 1120mm / 44" L: 1300mm / 51" XL: 1500mm / 59" M: 664mm / 26" L: 844mm / 33.2" XL: 1044mm / 41" 228mm/9"

Dedicato agli amanti della natura e dell'avventura, una nuova filosofia di viaggio, tempo libero e vacanze nella totale libertà di spostamento.

Dedicated to nature and adventure lovers, a new philosophy of travel, free time, holidays in total freedom of movement.

ACCESSORI PER:
PICK UP,
CARRELLI RIMORCHI,
VAN E CARAVAN.

ACCESSORIES FOR:
PICK UP,
TRAILERS,
VAN AND CARAVAN.



TBR TRUCK BED RACK SYSTEM

Barre universali bed truck per pickup con profilo largo e piatto in alluminio e scanalatura T-system per il montaggio in cava di vari accessori. Dotate di serratura antifurto.

Universal truck bed crossbars with large and flat aluminum profile with grooving for T-System bolts. Equipped with anti-theft lock.



Art.000125700000



Profilo in alluminio largo e piatto con cava per T-System. Large and flat aluminium profile with T-System slot.



Cover frontale con serratura antifurto di serie. Front cover with antitheft lock.



Sistema di fissaggio tramite leva che permette lo scorrimento delle barre nel supporto in alluminio. Quick lever fastenign system that allows the sliding of the bars in the aluminum support.



Compatibile con truck bed covers provviste di corsia per montaggio di accessori tramite viti a "T". Compatible with truck bed covers equipped with T-bolts tracks.

Optional Truck bed rack fixing profile kit

Supporto in alluminio per l'installazione delle barre trasversali per pickup. Questo accessorio rappresenta la soluzione ideale per quei veicoli che non sono dotati di cassoni con scanalatura per T-System, requisito necessario per l'installazione delle barre TBR.

Aluminium support for the truck bed crossbars. This accessory represents the ideal solution for those vehicles that are not equipped with beds with "T" grooves, a necessary requirement for the installation of the TBR bars.



SNORKEL



Portabici da pianale completamente regolabile progettato per il montaggio all'interno dei cassoni dei pickup con cinghie di sicurezza.

Fully adjustable bike carrier, designed to carry one bike on the truck bed.

Art.000130800000

Extension Kit Ground 2.0 - Snorkel



Kit d'estensione che consente di trasportare comodamente più supporti Snorkel o Ground 2.0 contemporaneamente. Installazione con cinghie su furgoni, furgoncini o piattaforme posteriori dei pickup.

Extension kit that allows you to comfortably carry more Snorkel or Ground 2.0 supports at the same time. Installation with straps on vans or rear platforms of pickups.

M Art. 000140500000
XL Art. 000131100000

Enjoy
your
pickup
life



SLIDING BARS STRUCTURE FOR TRAILERS
STRUTTURA BARRE SCORREVOLI PER CARRELLI



La struttura a barre scorrevoli per carrello offre modularità e personalizzazione nel trasporto del carico.

Questo sistema, sfrutta la scanalatura per T-System dei profili che si installano sulla cornice del carrello e delle relative barre portatutto con serratura antifurto.

Permette un montaggio semplice e veloce delle barre, garantendo praticità e versatilità per le diverse esigenze di trasporto.

The sliding bars structure for trailers offers modularity and customization in load transport.

This system utilizes the T-System groove of the profiles that are installed on the trailer frame and the corresponding anti-theft lock crossbars.

It allows for easy and quick mounting of the bars, ensuring practicality and versatility for various transport needs.

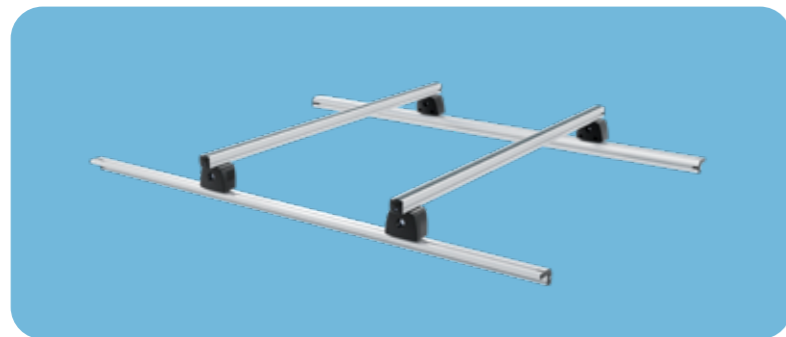

Art.000140100000



TREMONT

PROSSIMA USCITA
NEXT RELEASE

Design e specifiche potrebbero essere soggette a cambiamenti.
Design and specifications might be subject to change.



I portabicicli da Van in alluminio sono una soluzione eccellente per il trasporto di E-bike, offrendo robustezza e affidabilità.

La loro facilità di montaggio, che non richiede forature al veicolo, li rende una scelta pratica e rapida per chi desidera un'installazione senza complicazioni.

Compatible con diversi modelli di furgoni a seconda della versione:

- Tremont A: Fiat Ducato, Citroen Jumper, Peugeot Boxer, Ram ProMaster, Iveco Daily (<2007).
- Tremont B: VW Crafter (<2017) MB Sprinter (2006>).
- Tremont C: Renault Master (2018>)

Aluminum Van bike racks are an excellent solution for transporting E-bikes, offering robustness and reliability.

Their easy installation, which does not require drilling into the vehicle, makes them a practical and quick choice for those who want a hassle-free setup.

Compatible with various van models depending on the version:

- Tremont A: Fiat Ducato, Citroen Jumper, Peugeot Boxer, Ram ProMaster, Iveco Daily (<2007).
- Tremont B: VW Crafter (<2017) MB Sprinter (2006>).
- Tremont C: Renault Master (dal 2018>)

Optional Kit 000026400000
Pomello antifurto



Pomello antifurto ergonomico.
Ergonomic anti-theft knob.

Tremont A
Tremont B
Tremont C

Art.000148000000
Art.000148100000
Art.000148200000



TOUREN

PROSSIMA USCITA
NEXT RELEASE

Design e specifiche potrebbero essere soggette a cambiamenti.
Design and specifications might be subject to change.



I portabicicli da timone in alluminio sono una soluzione perfetta per trasportare le bici, incluse le E-bike.

La loro compatibilità con diversi timoni e la capacità di piegarsi, rendono questi supporti estremamente pratici e di facile installazione. La struttura in alluminio non solo garantisce leggerezza ma anche resistenza, assicurando così un trasporto sicuro e duraturo nel tempo.

Aluminum drawbar bike racks are a perfect solution for transporting bikes, including E-bikes.

Their compatibility with different drawbars and their foldable design make these racks extremely practical and easy to install. The aluminum structure not only ensures lightness but also durability, thus guaranteeing safe and long-lasting transportation.



Touren A Art.000148300000
Touren B Art.000148400000



P O R T A B I C I B I K E R A C K S

Travel enriches and teaches life.
The bicycle is a faithful friend that
can take you wherever you want.

Traveling by bicycle is a strong
emotion, follow the path that your
emotions indicate.

Il viaggio arricchisce ed è maestro di vita.
La bicicletta è un'amica fedele che può condurti
ovunque desideri.

Viaggiare in bicicletta è un'emozione forte.
Segui la strada che ti indicano le emozioni.



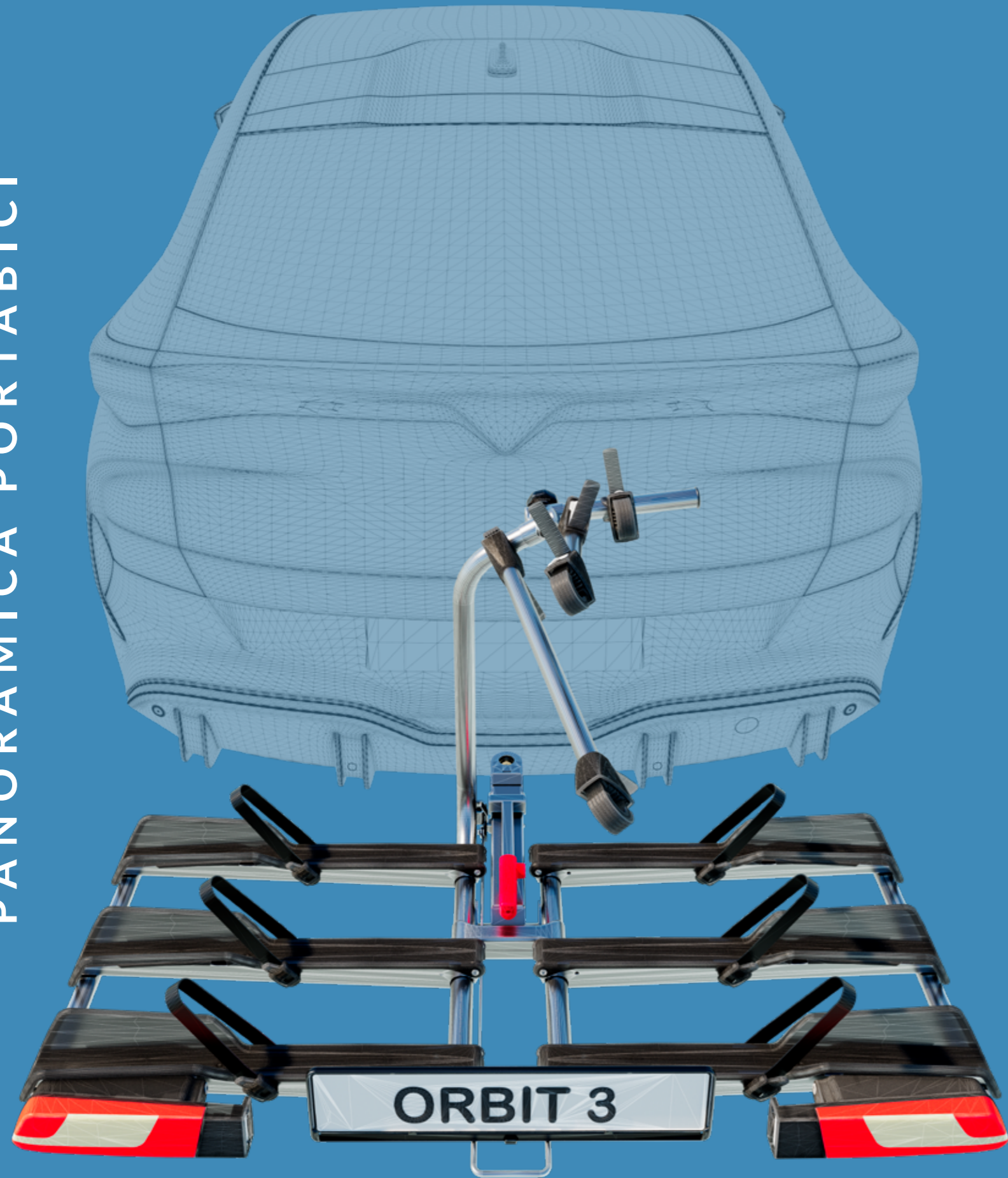

Nuovo portabici da gancio traino
New towbar bike racks



B r e a t h e
t r u e
n a t u r e

L' eleganza del
tuo portabici
da tetto

The elegance of
your roof bike
rack



PRO TOUR CLOVER

Black



COMPLIANT WITH
DIN 75302:2019

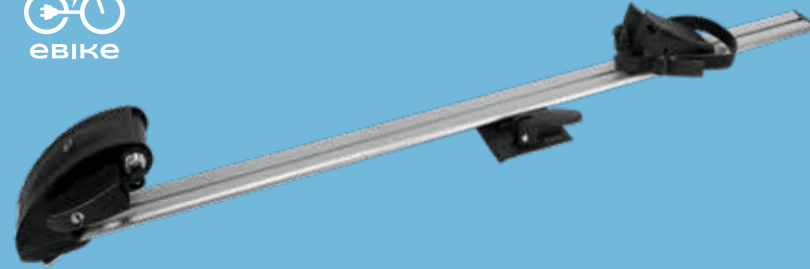

Portabici da tetto professionale realizzato in alluminio, pensato per chi preferisce caricare la propria bici direttamente sulle barre. È dotato di un sistema di aggancio della forcella sia tradizionale che ammortizzata.

Consigliato per le bici con telaio in carbonio e indicato anche per quelle con freno a disco anteriore. Dotato di doppio sistema antifurto.

Professional aluminium bike rack conceived for those who prefer carrying their bike directly on the roof bars. Both traditional and cushioned forks can be attached to the locking system.

It is recommended for bikes with carbon frame and/or with front disc brake. Equipped with double anti-theft system.

Optional Kit adapters

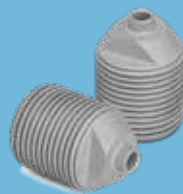

- ø12x100mm / ø0.5x4"
- ø15x100mm / ø0.6x4"
- ø15x110mm / ø0.6x4.3"
- ø15x150mm / ø0.6x6"
- ø20x110mm / ø0.8x4.3"

- Art.000094800000
- Art.000086900000
- Art.000094600000
- Art.000087100000
- Art.000087000000

Montaggio rapido della bici tramite adattatori interscambiabili. Kit con perno passante da ø9x100mm/ ø0.3x4" incluso.

Quick assembly of the bike via interchangeable adapters. Kit with ø9x100mm/ ø0.3x4" thru-axle included.

Art.000086100000



Dx

Sx

Portabici da tetto adatto ad un'ampia gamma di bici tra cui Fat bike, E-bike e consigliato per MTB. Realizzato in alluminio e acciaio, è progettato per rispondere ai più alti standard di sicurezza, senza tralasciare il design. Dotato di doppio sistema antifurto.

Roof mounted bike carrier suitable for a wide variety of bikes, such as Fat bikes and E-bikes. Made of aluminium and steel, it is designed to comply with the highest safety standards, without compromising the design. Equipped with double anti-theft system.

Optional Kit 000122700000



Sistema di fissaggio esterno alle barre da tetto. U-bolts fixing around the roof bars.

Dx Art.000133800000
Sx Art.000123000000



JUZA



COMPLIANT WITH
DIN: 7530:2019

Portabici da tetto per MTB e bici da corsa. Realizzato esclusivamente in alluminio e plastiche pregiate. Progettato per rispondere ai più alti standard di sicurezza, senza tralasciare il design. Dotato di doppio sistema antifurto.

Roof mounted bike carrier suitable for large size bikes, MTB and racing bikes. Exclusively aluminium made with valuable plastics parts, it is designed to comply with the highest safety standards, without compromising with the design. Equipped with double anti-theft system.

Optional Kit 000122700000



Sistema di fissaggio esterno alle barre da tetto. U-bolts fixing around the roof bars.

Art.000081000000



MOTUS

Black



Portabici da tetto con struttura in alluminio e braccio ferma telaio regolabile. Dotato di sistema antifurto per carico e portabici.

Roof mounted bike carrier with aluminium structure and adjustable frame arm holder. Equipped with antitheft system for both bike rack and bike.

Optional Kit 000146000000



Sistema di fissaggio esterno alle barre da tetto. U-bolts fixing around the roof bars.

Art.000145700000



Il portabici
da gancio
perfetto per te

The towbar
bike
carrier
perfect
for you



COSMIC



Portabici da gancio richiudibile con sistema di aggancio rapido, telaio in acciaio ad alta resistenza e profili in alluminio. Dotato di sistema di ribaltamento a pedale e di doppio antifurto. Adatto al trasporto di e-bike o fat bike. Disponibile in 2 modelli.

Foldable towbar bike rack with quick fixing system, sturdy steel frame and large aluminium wheel rails. Equipped with a pedal tilting system and double antitheft system. Suitable for e-bikes or fat bikes. Available in 2 models.



Cosmic 2 | Art. 000149000000 Cosmic 3 | Art. 000148900000

ALIOTH



Portabici da gancio con sistema di aggancio rapido, telaio in acciaio ad alta resistenza e profili in alluminio. Dotato di sistema di ribaltamento a pedale e di sistema antifurto. Adatto al trasporto di e-bike o fat bike. Disponibile in 2 modelli.

Towbar bike rack with quick fixing system, sturdy steel frame and large aluminium wheel rails. Equipped with a pedal tilting system and antitheft system. Suitable for e-bikes or fat bikes. Available in 2 models.



Alioth 2 | Art. 000149200000 Alioth 3 | Art. 000149100000

Optional Kit 000026400000 | ALIOTH/MERAK Pomello antifurto



Pomello antifurto ergonomico. Ergonomic anti-theft knob.

MERAK



Portabici da gancio compatto e leggero con profili in alluminio. Adatto al trasporto di e-bike. Disponibile in 3 versioni.

Compact and lightweight towbar bike rack with aluminium rails. Suitable for e-bikes. Available in three models.



Merak S
Art. 000117600000



Tip S
Fixing System

Sistema di fissaggio al gancio traino tramite vite centrale.

Fixing system to the tow hook by means of a central screw.



Merak K
Art. 000117700000



Tip K
Fixing System

Sistema di fissaggio al gancio traino tramite vite centrale con leva di ribaltamento portabici.

Fixing system to the tow hook by means of a central screw, complete with tilting system lever.



Merak Q
Art. 000119100000



Tip Q
Fixing System

Sistema di fissaggio con maniglia di chiusura rapida e leva per ribaltamento portabici. Con serratura antifurto.

Fixing system with quick closing handle and tilting system lever. Anti-theft lock included.

Optional Kit 000117800000



Kit di estensione per il trasporto di una bici aggiuntiva. Extension kit for carrying an extra bike.



Nature
and
happiness

ORBIT 2 / 3 / 4

PROSSIMA USCITA
NEXT RELEASE

Design e specifiche potrebbero essere soggette a cambiamenti.
Design and specifications might be subject to change.

Orbit 2 | 2 Bikes | Art. 000147500000
Orbit 3 | 3 Bikes | Art. 000147600000
Orbit 4 | 4 Bikes | Art. 000147700000



Nuovo portabici da gancio traino dal design originale. Dotato di sistema di ribaltamento, rapid lock e serratura antifurto per una maggiore sicurezza. Compatibile con bici di grossa taglia grazie alla maggiore distanza tra i binari, incluse le E-bike.

Estremamente compatto per un agevole rimessaggio e trasporto.

New towbar bike rack with an original design. Equipped with a tilting system, rapid lock, and anti-theft lock for increased security. Compatible with large bikes due to the greater distance between the rails, including E-bikes.

Extremely compact for easy storage and transport.



Your rear bike
racks,
your
comfort



Il tuo portabici
posteriore,
il tuo comfort

STAND UP



Portabici posteriore con struttura in acciaio e corsie in alluminio. Richiudibile e semplice da montare sul retro dell'auto con cinghie e supporti in gomma antigraffio. Disponibile in due versioni per 2 o 3 bici.

Rear bike carrier with steel frame and aluminium rails. Foldable and easy to install on the car's hatch. Available in two models for 2 or 3 bikes, equipped with anti-skretch rubber feet.

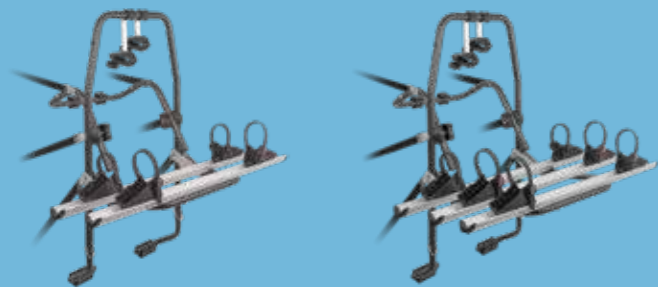

Stand Up 2
Art: 000063400000

Stand Up 3
Art: 000063500000

Optional Kit 000026400000
Pomello antifurto



Pomello antifurto ergonomico.
Ergonomic anti-theft knob.



SHADOW

Black



COMPLIANT WITH
DIN 75303:2019

COMPLIANT WITH
ISO/PAS 11154:2006

Portabici esclusivo per veicoli Volkswagen Caddy, T5 e T6. Realizzato in acciaio con canale in alluminio, è in grado di trasportare fino a 3 biciclette, fat bike comprese.

Bike rack for Volkswagen Vans Caddy, T5 and T6. Steel frame with aluminium rails to carry up to 3 bikes, including fat bikes.



Shadow Black Caddy (2K) 2015>2021
Art: 000144900000

Shadow Black T5 2003>2015
Art: 000145000000

Shadow Black Caddy (SB) 2.0 2021>
Art: 000145100000

Shadow Black T6 2015>
Art: 000144800000



COBRA



Portabici posteriore in acciaio con canale in alluminio. Compatibile con bici di grossa taglia, come fat bike o e-bike. Sicuro, semplice e rapido da montare.

Rear mounted bike carrier, made of steel with aluminium rails. Suitable for e-bikes and fat bikes. Easy and quick to install on the car's hatch.

Optional Kit 000026400000
Pomello antifurto



Pomello antifurto ergonomico.
Ergonomic anti-theft knob.

Art.000134300000



COBRA PLUS



Portabici posteriore in acciaio con canale in alluminio. Sicuro, semplice e rapido da montare con cinghie di fissaggio.

Rear mounted bike carrier, made of steel with aluminium rails. Easy and quick to install on the car's hatch, with safety straps.

Optional Kit 000026400000
Pomello antifurto



Pomello antifurto ergonomico.
Ergonomic anti-theft knob.

Art.000133100000



MISTRAL

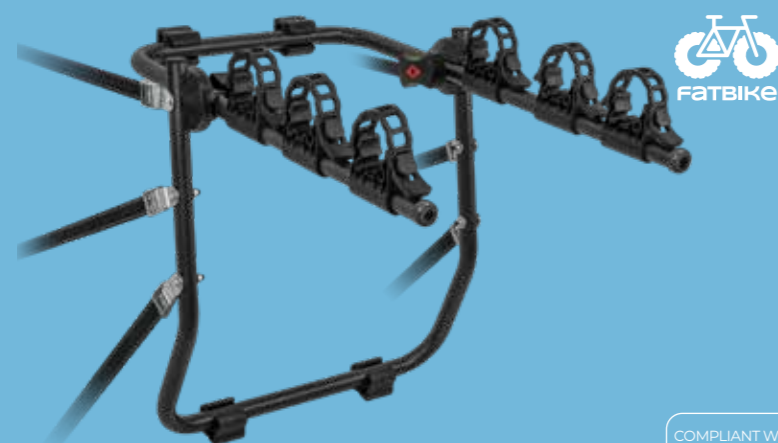

COMPLIANT WITH
XP R18-904-4:2008

Portabici posteriore in acciaio adatto al trasporto di tre biciclette fissate al supporto ferma telaio. Richiudibile e semplice da montare con cinghie e supporti in gomma antigraffio.

Rear mounted bike carrier made of steel, suited for carrying three bikes. Foldable and easy to install on the car's hatch.

Art. 000009000000



VIPER



Portabici posteriore in acciaio dallo stile originale adatto al trasporto di tre biciclette fissate al supporto ferma telaio. Sicuro, semplice e rapido da montare con cinghie e supporti in gomma antigraffio.

This rear mounted bike carrier, completely made of steel, is suited for carrying three bikes. Easy and quick to install on the car's hatch.

Art. 000123800000



SCHEDA TECNICA PORTABICI BIKE RACKS TECHNICAL DATASHEET

Compatibilità biciclette Bicycle compatibility

Art.				
PRO TOUR	-	min 22" max 29"	max 110mm/4.3"	max 1200mm/47.2"
CLOVER	-	min 26" max 29"	max 110mm/4.3"	max 1260mm/49.6"
JUZA		min: 25mm/1" max: 60mm/2.3" min: 25x60mm/1.2x2.3" max: 25x60mm/1.2x2.3"	min 22" max 29"	max 75mm/3"
MOTUS		min: 25mm/1" max: 80mm/3.1" min: 25mm/1" max: 80mm/3.1"	min 22" max 29"	max 75mm/3"
COSMIC		min: 23mm/1" max: 75mm/3" min: 30x50mm/ 1.2x2" max: 50x75mm/ 2x3"	min 22" max 29"	max 110mm/4.3"
ALIOTH		min: 23mm/1" max: 75mm/3" min: 30x50mm/ 1.2x2" max: 50x75mm/ 2x3"	min 22" max 29"	max 110mm/4.3"
MERAK		min: 30mm/1.2" max: 50mm/2" min: 30x60mm/1.2x2.3" max: 50x70mm/2x2.7"	min 22" max 29"	max 65mm/2.5"
STAND UP		min: 30mm/1.2" max: 50mm/2" min: 30x60mm/ 1.2x2.4" max: 50x70mm/ 2x2.7"	min 22" max 29"	max 75mm/3"
SHADOW black Caddy (2K) 2015>2021 Black T5/ Black T6		min: 30mm/1.2" max: 50mm/2" min: 30x60mm/ 1.2x2.4" max: 50x70mm/ 2x2.7"	min 22" max 29"	max 110mm/4.3"
SHADOW black Caddy (SB) 2.0 2021>		min: 23mm/1" max: 75mm/3" min: 30x60mm/ 1.2x2.4" max: 50x70mm/ 2x2.7"	min 22" max 29"	max 110mm/4.3"
COBRA		min: 23mm/1" max: 75mm/3" min: 30x50mm/ 1.2x2" max: 50x75mm/ 2x3"	min 22" max 29"	max 110mm/4.3"
COBRA PLUS		min: 23mm/1" max: 75mm/3" min: 30x50mm/ 1.2x2" max: 50x75mm/ 2x3"	min 22" max 29"	max 65mm/2.5"
MISTRAL		min: 25mm/1" max: 60mm/2.3" min: 30x50mm/ 1.2x2" max: 50x75mm/ 2x3"	No limit	No limit
VIPER		min: 25mm/1" max: 60mm/2.3" min: 30x50mm/ 1.2x2" max: 50x75mm/ 2x3"	No limit	No limit

Art.	Antifurto bici Anti-theft lock for bike 	Antifurto porta bici Anti-theft lock for bike rack 		Max 	Fat Bike	E-Bike
PRO TOUR	✓	✓	17Kg / 37 lb	1	✓	✓
CLOVER	✓	✓	25kg/55lb	1	✓	✓
JUZA	✓	✓	15kg/33lb	1	X	X
MOTUS	✓	✓	20kg/44lb	1	X	X
COSMIC	✓	✓	60kg/132lb	2/3	✓	✓
ALIOTH	Optional	✓	60kg/132lb	2/3	✓	✓
MERAK	Optional	Only type Q	45kg/99lb	2+1	X	✓
STAND UP	Optional	X	45kg 99lb	2/3	X	✓ max 2
SHADOW	✓	✓	45kg/99lb	3	✓	✓ max 2
COBRA	Optional	X	45kg/99lb	2	✓	✓ max 2
COBRA PLUS	Optional	X	45kg/99lb	3	X	X
MISTRAL	X	X	45kg/99lb	3	✓	X
VIPER	X	X	45kg/99lb	3	✓	X

La tua
passione
è anche la
nostra

Your
passion
is also
there
out





ACCESSORI
PORTABICI

BIKE RACKS
ACCESSORIES

MENABO
free time on the move



BRACCIO FERMATELAIO 2022
Braccio ferma telaio. Pomello antifurto acquistabile separatamente

Bike frame holder arm. Anti-theft knob available for purchase separately.

- S Art.000128900000
- L Art.000129100000
- D Art.000129000000
- XL Art.000131000000



BRACCETTO FERMATELAIO
Braccio ferma telaio con serratura antifurto in dotazione.

Bike frame holder arm with anti-theft lock.

- S Art.000103900000
- L Art.000104000000
- D Art.000104100000
- S+L Art.000119700000
- 2x S Art.000119600000
- 2x S+1x L Art.000119800000
- S+L+D Art.000119900000
- 1x S+1x L+2x D Art.000120000000



POMELLO ANTIFURTO
Pomello antifurto ergonomico.

Ergonomic anti-theft knob.

- 1pz. Art.000026400000
- 2pz. Art.000119300000
- 4pz. Art.000119400000
- 6pz. Art.000119500000



CINGHIA
Cinghia di sicurezza.

Safety strap.
2pz. 2,5m | Art.000063200000
1pz. 5m | Art.000063300000

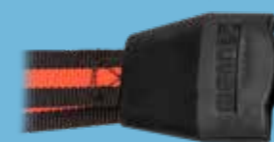

OYSTER
Cover protettiva in gomma per cinghie di sicurezza.

Protective rubber cover for safety straps.

Art.000133200000



PANNELLO PER CARICHI SPORGENTI
Pannello per carico sporgente.

Overhanging load warning panel.

Art.000014780000



VITI TQ 20X20 SCREWS KIT
4x TQ 20x20 M6x25
4x TQ 20x20 M6x35
4x TQ 20x20 M6x45

Art.000110100000



RAMPA
Rampa per agevolare il carico e lo scarico delle bici.

Ramp to facilitates the loadind and unloading of the bicycles.

Art.000082100000



PLACCA LUCI
Placca portatarga con fanali 7 pin.

Rear license plate holder with 7-pin lights.

Art.000027600000



PORTATARGA
Portatarga posteriore in A.B.S.

A.B.S rear license plate holder.

Art.000104500000



PLACCA TARGA RIPETITRICE
Placca targa ripetitrice.

Repeater plate.

Art.000147900000



FRAME ADAPTER BLACK 2.0
Adattatore per il fissaggio di bici.

Frame adapter to fit bikes with non-standard frame.

Art.000146200000

Porta con te tutto ciò di cui hai bisogno, senza rinunciare a nulla, lo spazio te lo dedichiamo noi!

Take everything with you without leaving anything, we'll dedicate the space to you!

BAULI E
PORTAPACCHI

ROOF BOXES
AND BASKETS



DIAMOND

450 - 450 Duo Black | 500 - 500 Duo Black

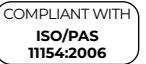

Baule da tetto elegante ed aerodinamico equipaggiato con sistema antifurto brevettato a doppio scatto. Sistema di montaggio rapido e sicuro tramite viti a "T" o supporti ad "L" come optional.

La versione Duo è fornita con doppia serratura ed apertura su entrambi i lati del baule. Disponibile in dimensioni fino a 500lt di capienza.

Elegant and aerodynamic roof box equipped with a patented anti-theft system. Quick and secure fastening system to the roof bars using "T-screws" or optional kit "L-brackets".

Also available in a version Duo with dual-sided opening and lock on both sides. Sizes up to 500lt of capacity.



Optional Kit 000082500000

Sistema di montaggio esterno alle barre tramite supporti ad "L".

Optional L-bracket external fastening system to the roof bars.



Serratura antifurto brevettata che consente di rimuovere la chiave solo se il coperchio è completamente chiuso.

Patented anti-theft lock that allows the key to be removed only when the lid is fully closed.



Dotato di sistema di fissaggio alle barre da tetto usando viti a "T".

Equipped with fastening system to the roof bars using "T-screws".



Pomello di chiusura rapida per un montaggio veloce e semplice.

Quick closing knob for easy and fast installation.



Apertura su entrambi i lati per un più facile accesso al carico.

Dual-sided opening for easier access to the load.

Diamond 450/450 Duo



Black
Duo Black

Art.000081500000
Art.000093100000

Diamond 500/500 Duo



Black
Duo Black

Art.000079000000
Art.000081400000

Art.

Diamond
450/450 Duo
Diamond
500/500 Duo

Dimensioni esterne
External dimensions
1631x369x907 mm
64.2x14.5x35.7"
2083x366x794 mm
82x14.4x31.2"



SATELLITE

550 Duo Black - 600 Duo Black



Baule da tetto elegante e aerodinamico dotato di sistema antifurto brevettato a doppio scatto. Sistema di fissaggio alle barre da tetto tramite viti a "T" o tramite supporti optional a "L". Dotato di doppia apertura e serratura su entrambi i lati. Misure fino a 600lt di capienza.

Elegant and aerodynamic roof box equipped with a patented anti-theft system. Quick and secure fastening system to the roof bars using "T-screws" or optional kit "L-brackets". Equipped with dual-sided opening and lock on both sides. Sizes up to 600lt of capacity.



Dotato di sistema di fissaggio alle barre da tetto usando viti a "T".
Equipped with fastening system to the roof bars using "T-screws".



Pomello di chiusura rapida per un montaggio veloce e semplice.
Quick closing knob for easy and fast installation.

Satellite 550/600 Duo Black



550 Duo Black Art.000142900000
600 Duo Black Art.000142800000

Art.	Dimensioni esterne External dimensions
Satellite 550 Duo Black	1985x405x949 mm 78.1x15.9x37.3"
Satellite 600 Duo Black	1976x479x941 mm 77.7x18.8x37"



Optional Kit 000082500000

Optional kit di fissaggio esterno alla barre da tetto tramite supporti a "L".

Optional L-bracket external fastening system to the roof bars.



Serratura antifurto brevettata che consente di rimuovere la chiave solo se il coperchio è completamente chiuso.

Patented anti-theft lock that allows the key to be removed only when the lid is fully closed.



Apertura su entrambi i lati per un più facile accesso al carico.

Dual-sided opening for easier access to the load.





Baule da tetto progettato con un profilo affusolato e dotato di sistema antifurto. Montaggio rapido e sicuro. Disponibile in varie misure e colori.

Roof box with a streamlined design equipped with anti-theft lock. Safe and speedy fixing. Available in various sizes and colors.

320/400/460



Sistema di montaggio esterno alle barre tramite supporti ad "U".

Fixing system external to the bars through "U" supports.

400/460



Sistema di montaggio rapido interno alle scanalature delle barre tramite viti a "T" da 20mm o 13mm.

Quick fixing system inside the groove of the bars by means of 0.8" and 0.5" T screws.

320/400/460

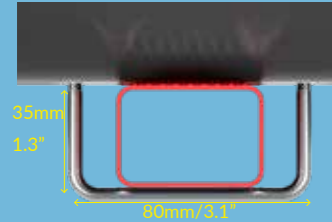

Optional Kit 000124600000

Sistema di montaggio esterno alle barre tramite supporti ad "U".

Fixing system external to the bars through "U" supports.

320/400/460



Optional Kit 000120100000

Sistema di fissaggio alle barre da tetto tramite viti a "T" da 20mm o 13mm.

Optional fastening system to the roof bars using 0.8" and 0.5" "T-screws".

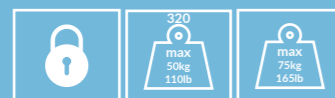

Mania 320



320 Black Art.000036100000

Mania 400



400 Black Art.000034000000
400 White Art.000033900000

Mania 460



460 Black Art.000034300000
460 White Art.000034200000

Art.	Dimensioni esterne External dimensions
Mania 320	1363x364x777 mm 53.6x14.3x30.5"
Mania 400	1653x364x781 mm 65x14.3x30.7"
Mania 460/460 Duo	1925x363x772 mm 75.7x14.3x30.4"
Mania 580/580 Duo	2244x364x891 mm 88.3x14.3x35"



460 Duo/580/580 Duo



Sistema di montaggio esterno alle barre tramite supporti ad "L".

Fixing system external to the roof bars via L-shaped supports.

460 Duo/580/580 Duo



Pomello di chiusura rapida con staffa per cinghia fermacarico.

Locking knob with bracket for load securing strap.

460 DUO / 580 DUO



Apertura da entrambi i lati per accedere al carico in modo più agevolato.

Dual-sided opening for easy access on either side of your vehicle.

Mania 460 Duo Black Duo Art.000035400000

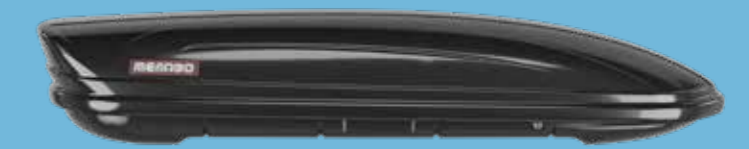

Mania 580 580 Black Art.000034500000



Mania 580 Duo Black Duo Art.000035600000



400 Duo/580/580 Duo



Optional Kit 000063600000

Sistema di fissaggio alle barre da tetto tramite viti a "T".

Optional fastening system to the roof bars using "T-screws".



STARLA

500 Duo Black - 500 Duo Dark



Baule da tetto dal design esclusivo e aerodinamico studiato per ottimizzare il flusso dell'aria intorno al box. Montaggio veloce e sicuro senza necessità di utensili. Apertura doppia su entrambi i lati, per eseguire con facilità operazioni di fissaggio, carico e scarico. Il sistema di chiusura centralizzata a 3 punti offre la massima sicurezza. La chiave in dotazione può essere estratta solo se il sistema di chiusura è correttamente chiuso.

Roof box designed with an aerodynamic profile to optimize the air flow around the box. Fast and safe assembly without the need for tools. Dual side opening to make fixing, loading and unloading easier. The 3-points central locking system offers maximum security. The key supplied can only be extracted if the box is closed correctly.



Optional Kit 000145400000

Sistema di montaggio rapido esterno alle barre da tetto.

Quick fixing system external to the roof bars.



Pomello di chiusura rapida per un montaggio veloce e semplice.
Quick closing knob for a quick and simple fixing.



Apertura da entrambi i lati per accedere al carico in modo più agevolato.

Dual-sided opening for easy access on either side of your vehicle.



Serratura antifurto brevettata che consente di rimuovere la chiave solo se il coperchio è completamente chiuso.

Patented anti-theft lock that allows you to remove the key only if the lid is fully closed.



Sistema di montaggio rapido interno alle scanalature delle barre tramite viti a "T".

Quick fixing system inside the groove of the bars by means of "T" screws.

Starla 500 Duo Black



Duo Black Art.000145300000

Starla 500 Duo Dark



Duo Dark Art.000145200000

Art.	Dimensioni esterne External dimensions
Starla 500 Duo Black	1999x410x840 mm 78.7x16.1x33.1"
Starla 500 Duo Dark	1999x410x840 mm 78.7x16.1x33.1"



S p a c e
a n d
c o m f o r t



Y O S E M I T E



Yosemite L Black



Art.000131400000

Yosemite XL Black



Art.000131500000

Bagagliaia da tetto versatile e resistente con struttura in alluminio. Sistema di montaggio rapido tramite viti a "T" o supporti ad "U". Dotata di sistema antifurto. Disponibile in due misure.

Versatile and durable roof basket with aluminum structure. Quick assembly system using "T" screws or "U" bolts. Equipped with anti-theft system. Available in two sizes.



Sistema di montaggio esterno alle barre tramite cavallotti ad "U".
Fixing system external to the roof bars via "U" bolts.



Sistema di montaggio rapido interno alle scanalature delle barre tramite viti a "T".
Quick fixing system inside the groove of the bars by means of "T" screws.



Cover protettiva con serratura antifurto.
Protective cover with anti-theft lock.



Passanti scorrevoli per cinghie di sicurezza per il carico.
Sliding loops for cargo securing straps.



Optional Cargo net
000111500000

Rete di sicurezza per bagagliere e piattaforme da tetto Menabo.

Safety net for Menabo roof baskets and roof platforms.



Art.	Dimensioni esterne External dimensions
Yosemite L	1492x956 mm 58.7"x36.6"
Yosemite XL	1872x1236 mm 73.7"x48.6"

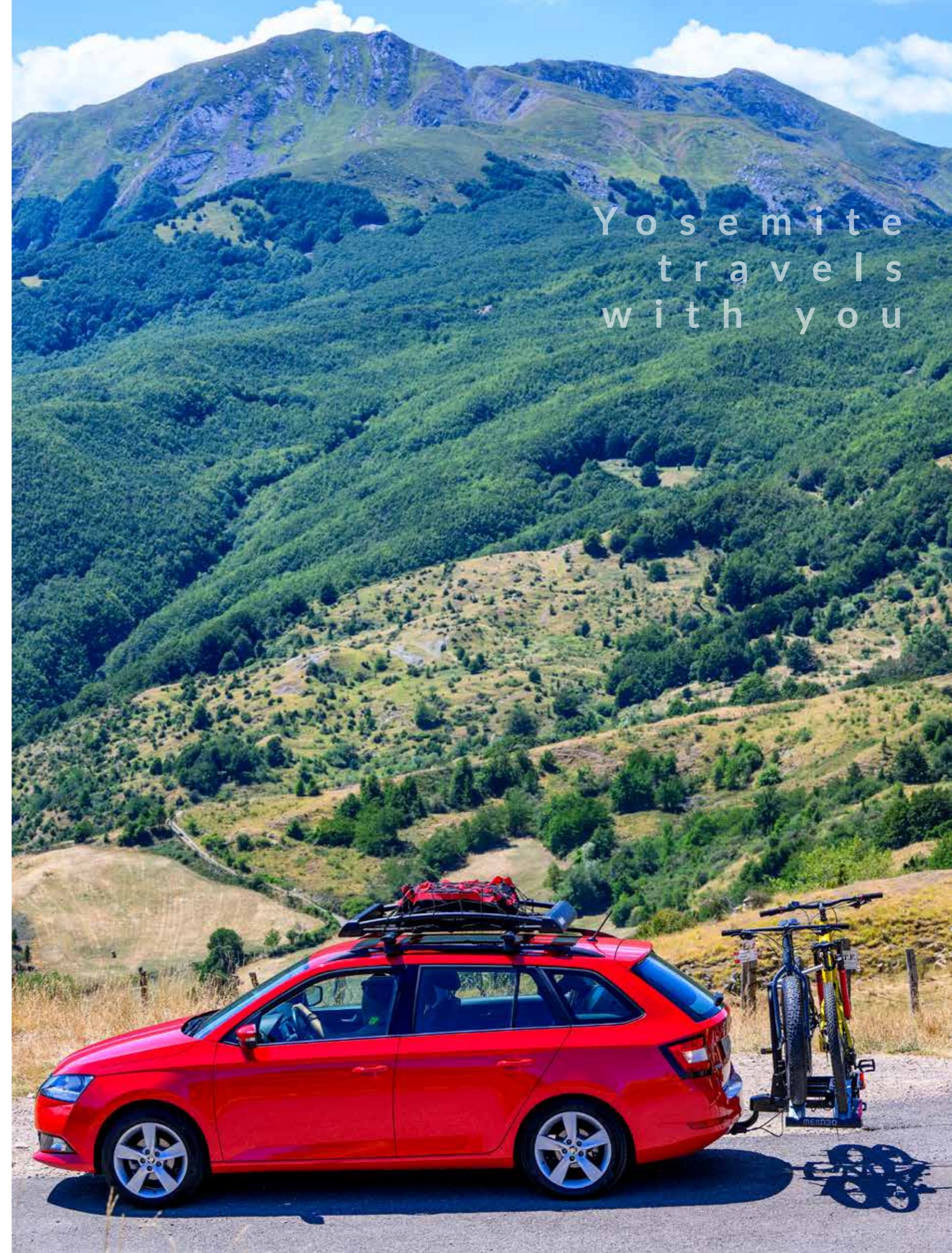

Y o s e m i t e
t r a v e l s
w i t h
y o u

SEQUOIA



Sequoia M



Art. 000126200000

Sequoia XL

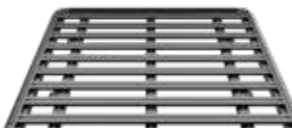

Art.000128000000

Piattaforma portapacchi da tetto versatile e resistente in alluminio. Sistema di montaggio rapido tramite viti a "T" o supporti ad "U". Dotata di sistema antifurto. Disponibile in due misure.

Versatile and durable roof rack platform with aluminum structure. Quick assembly system using "T" screws or "U" bolts. Equipped with anti-theft system. Available in two sizes, made completely of aluminium.



Sistema di montaggio esterno alle barre tramite cavallotti ad "U".
Fixing system external to the roof bars via "U" bolts.



Sistema di montaggio rapido interno alle scanalature delle barre tramite viti a "T".
Quick fixing system inside the groove of the bars by means of "T" screws.

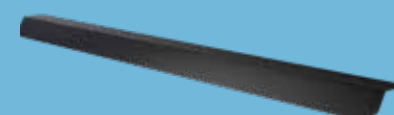

DEFLETTORE ANTERIORE
Deflettore anteriore per piattaforma incluso.

Front deflector for platform included.



OPTIONAL SCALETTA

Scala resistente e versatile, essenziale per garantire un accesso sicuro e pratico al carico.

Resistant and versatile ladder, essential for ensuring safe and practical access to the load.
Art: 000148800000



Cover protettiva con serratura antifurto.
Protective cover with anti-theft lock.



Profili con slot per il montaggio rapido degli accessori tramite viti a "T".
Profiles with slots for quick mounting of accessories through T-bolts.



Art.	Dimensioni esterne External dimensions
Sequoia M	1642mmx1300 mm 64.4"x51.1"
Sequoia XL	2042mmx1400mm 80.4"x55.1"

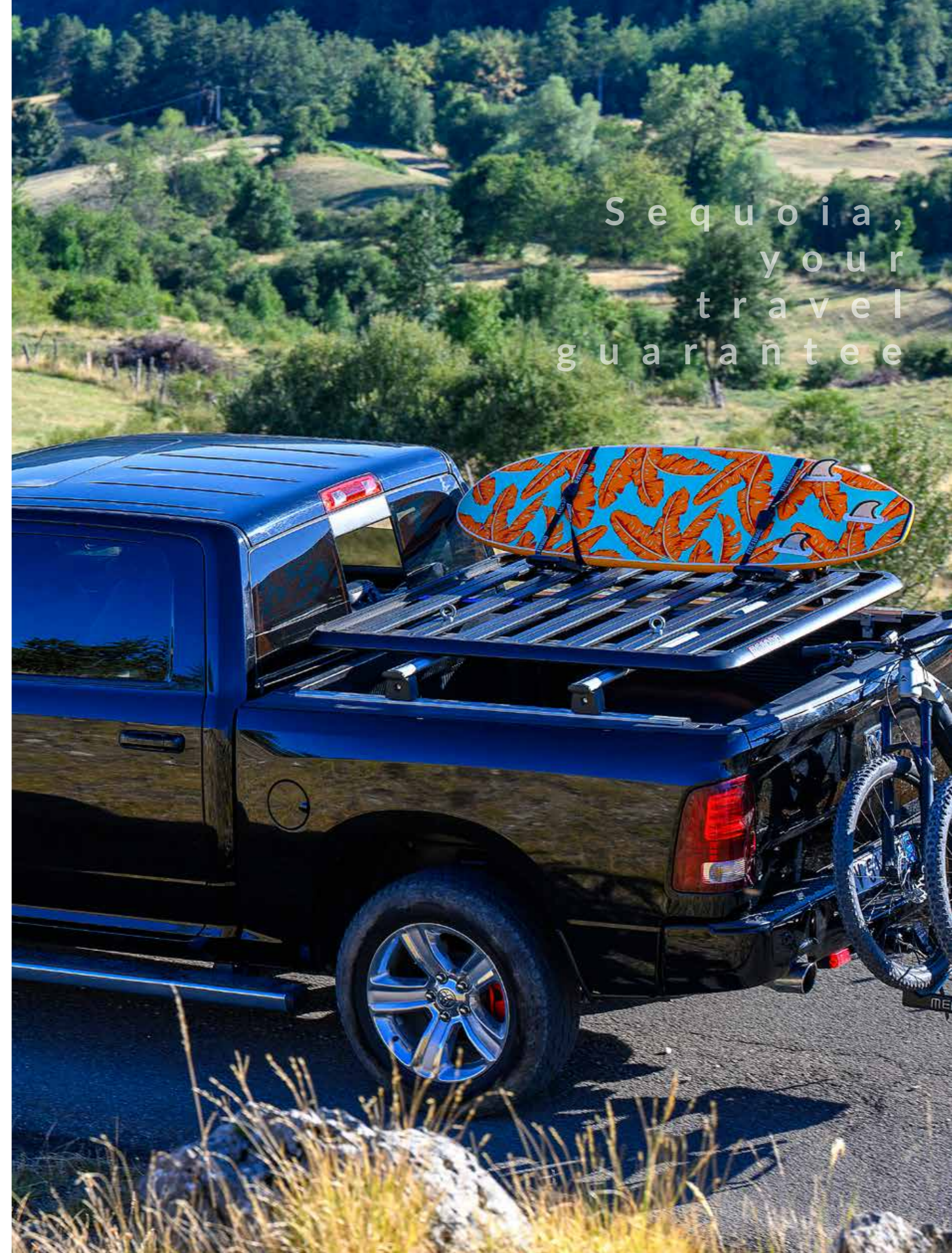

Sequoia,
your
travel
guarantee

In famiglia
in coppia o
con gli amici,
esplora il mondo
con noi



With family
with your half
or with friends,
explore the world
with us

M I Z A R

Exclusive ALCOR 3



Baule posteriore per portabici da gancio traino. Rapido da montare e dotato di doppio sistema antifurto per baule e carico trasportato. Compatibile esclusivamente con portabici da gancio traino Menabo ALCOR 3.

Rear cargo box for towbar bike carriers. Equipped with double anti-theft system for trunk and carried load. Quick and easy fixing. Compatible only with Menabo ALCOR 3 towbar bike rack.

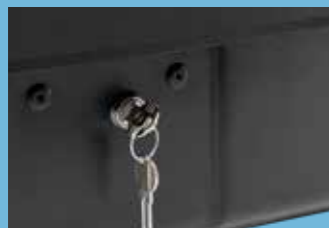

Serratura brevettata che consente di rimuovere la chiave solo se il coperchio è completamente chiuso.

Patented anti-theft lock that allows you to remove the key only if the lid is fully closed.



Sistema di fissaggio con morse che si agganciano al telaio del portabici. Pomello antifurto in dotazione.

Fixing to bike racks frame by means of clamps. Antitheft knob included.

Art.
Mizar

Dimensioni esterne
External dimensions
1151x538x674 mm
45.3x21.1x26.5"

Art.00078000000



N E K K A R



Baule posteriore universale per portabici da gancio traino e piattaforme con superfici di carico orizzontali.

Universal rear cargo box for towbar bike carriers and platforms with horizontal loading surfaces.

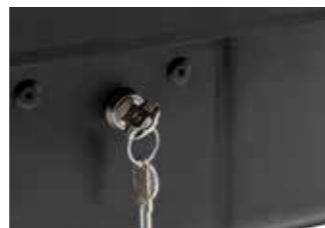

Serratura brevettata che consente di rimuovere la chiave solo se il coperchio è completamente chiuso.

Patented anti-theft lock that allows you to remove the key only if the lid is fully closed.



Sistema di montaggio esterno alle canale tramite supporti ad "U" da 80mm/3.1".

External fixing system through "U-shaped" supports measuring 80 mm/ 3.1".

Art.
Nekkar

Dimensioni esterne
External dimensions
1151x538x574 mm
45.3x21.1x22.5"

















Art.000121000000



M o m e n t s
n e v e r
d i e



SCHEDA TECNICA BAULI E PORTAPACCHI ROOF BOXES AND BASKETS TECHNICAL DATASHEET

Art.	Sistema di montaggio Fixing system	 max	 Volume	
DIAMOND 450/450 DUO	T- System External Kit 000082500000 (Optional)	75 Kg/ 165 lb	450 L	
DIAMOND 500/500 DUO	T- System External Kit 000082500000 (Optional)	75 Kg/ 165 lb	500 L	
SATELLITE 550 DUO	T- System External Kit 000082500000 (Optional)	75 Kg/ 165 lb	550 L	
SATELLITE 600 DUO	T- System External Kit 000082500000 (Optional)	75 Kg/ 165 lb	600 L	
MANIA 320	External Kit T-System Kit 000120100000 (Optional) External Kit 000124600000 (Optional)	50 Kg/ 110 lb	320 L	
MANIA 400	T system T-System Kit 000120100000 (Optional) External Kit External Kit 000124600000 (Optional)	75 Kg/ 165 lb	400 L	
MANIA 460	T system T-System Kit 000120100000 (Optional) External Kit External Kit 000124600000 (Optional)	75 Kg/ 165 lb	460 L	
MANIA 460 DUO	External Kit T-System Kit 000063600000 (Optional)	75 Kg/ 165 lb	460 L	
MANIA 580/580 DUO	External Kit T-System Kit 000063600000 (Optional)	75 Kg/ 165 lb	580 L	
STARLA 500 DUO	T system External Kit 000145400000 (Optional)	75 Kg/ 165 lb	500 L	
YOSEMITE	T system External Kit	75 Kg/ 165 lb	-	
SEQUOIA	T system External Kit	90 Kg/ 198 lb	-	
MIZAR	External Kit	30 Kg/ 66 lb	300 L	
NEKKAR	External Kit	30 Kg/ 66 lb	300 L	

Bauli e portapacchi a confronto Roof boxes and baskets comparison

Art.	Dimensioni Esterne (LxHxW) External Dimensions (LxHxW)
DIAMOND 450/450 DUO	1631 x 369x907mm 64.2 x 14.5 x 35.7"
DIAMOND 500/500 DUO	2083x366x794 mm 82x14.4x31.2"
SATELLITE 550 DUO	1985 x 405 x 949 mm 78.1 x 15.9 x 37.3"
SATELLITE 600 DUO	1976 x 479x 941 mm 77.7 x 18.8 x 37"
MANIA 320	1363 x 364 x 777 mm 53.6 x 14.3 x 30.5"
MANIA 400	1653 x 364 x 781 mm 65 x 14.3 x 30.7"
MANIA 460/460 DUO	1925 x 363 x 772 mm 75.7 x 14.3 x 30.4"
MANIA 580/580 DUO	2244 x 364 x 891 mm 88.3 x 14.3 x 35"
STARLA 500 DUO	1999 x 410 x 840 mm 78.7 x 16.1 x 33.1"

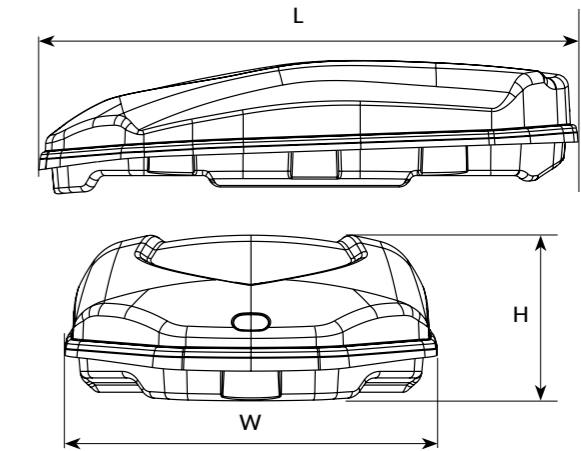

Art.	Dimensioni Esterne (LxHxW) External Dimensions (LxHxW)
YOSEMITE L	1492 x 956 mm 58.7 x 37.6"
YOSEMITE XL	1872 x 1236 mm 73.7 x 48.6"
SEQUOIA M	1642 x 1300 mm 64.4 x 51.1"
SEQUOIA XL	2042 x 1400 mm 80.4 x 55.1"

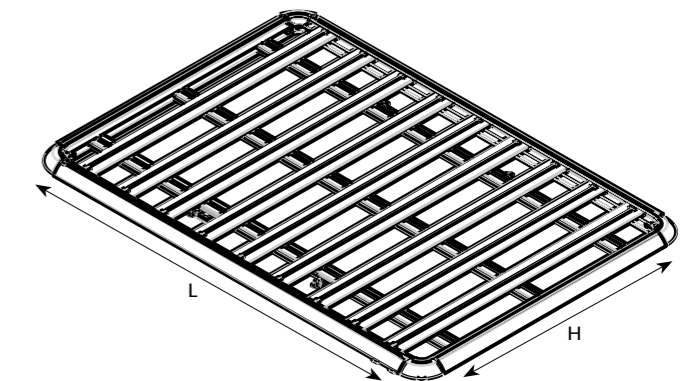

Art.	Dimensioni Esterne (LxHxW) External Dimensions (LxHxW)
MIZAR	1151 x 538 x 674 mm 45.3 x 21.1 x 26.5"
NEKKAR	1151 x 538 x 574 mm 45.3 x 21.1 x 22.5"

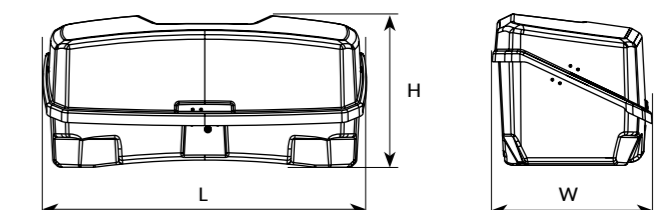

P O R T A S C I S K I R A C K S

Le piste da sci, le cime innevate delle montagne, il relax al rifugio, cosa c'è di meglio di una settimana bianca organizzata in ogni dettaglio?

The ski slopes, the snow-capped mountain peaks, relaxation at the refuge, what could be better than a skiing week organized in every detail?



Y E L O

+ Yelo Black

- TESTED CITY CRASH ✓
- COMPLIANT WITH DIN 75302:2019
- COMPLIANT WITH ISO/PAS 11154:2006

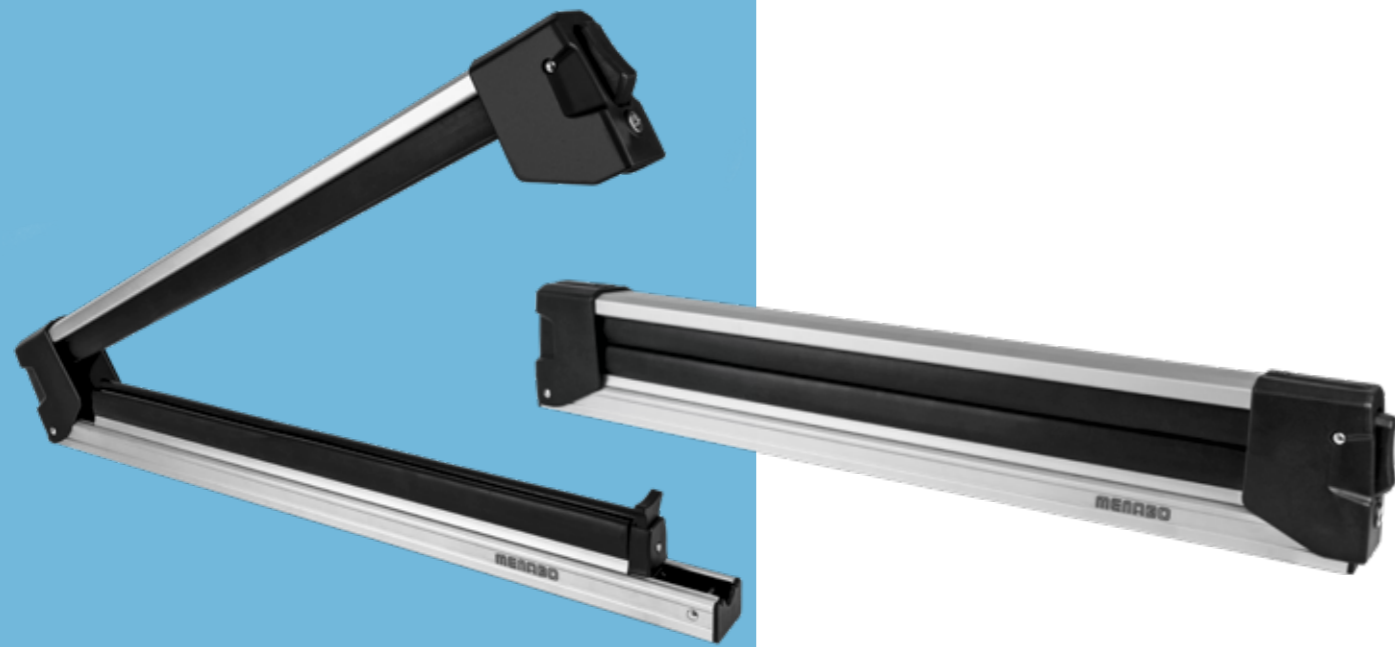

Portasci in alluminio progettato per trasportare 6 paia di sci o 4 snowboard. Equipaggiato con una base scorrevole per agevolare il carico o lo scarico degli sci o snowboard. Fissaggio semplice alle barre tramite t-system e sistema antifurto in dotazione.

Aluminium ski rack conceived for 6 pairs of skis, or 4 snowboards. It is equipped with a sliding base to facilitate the loading and unloading of skis and snowboards. It can be easily installed on the roof bars by means of standard T-system and features an anti-theft lock.

Yelo / Yelo Black



Yelo Art.000111600000
Yelo Black Art.000142000000



Alzando la leva "Slide", è possibile far scorrere verso l'esterno il carrello per agevolare il carico o scarico di sci e snowboard.

By lifting the "Slide" arm it is possible to glide out the base in order to facilitate the loading and unloading of skis and snowboards.



Sistema di montaggio rapido interno alle scanalature delle barre tramite viti a "T".

Quick fixing system inside the groove of the bars by means of "T" screws.



Serratura antifurto. Anti-theft lock.



Optional kit 000110300000
Kit opzionale per il montaggio del portasci all'esterno delle barre da tetto. Compatibile con profili larghi max 60 mm / 2.3".
Optional external fixing kit (max 60 mm / 2.3")

Y E L O 4 N S

+ Yelo 4NS Black

- TESTED CITY CRASH ✓
- COMPLIANT WITH DIN 75302:2019
- COMPLIANT WITH ISO/PAS 11154:2006

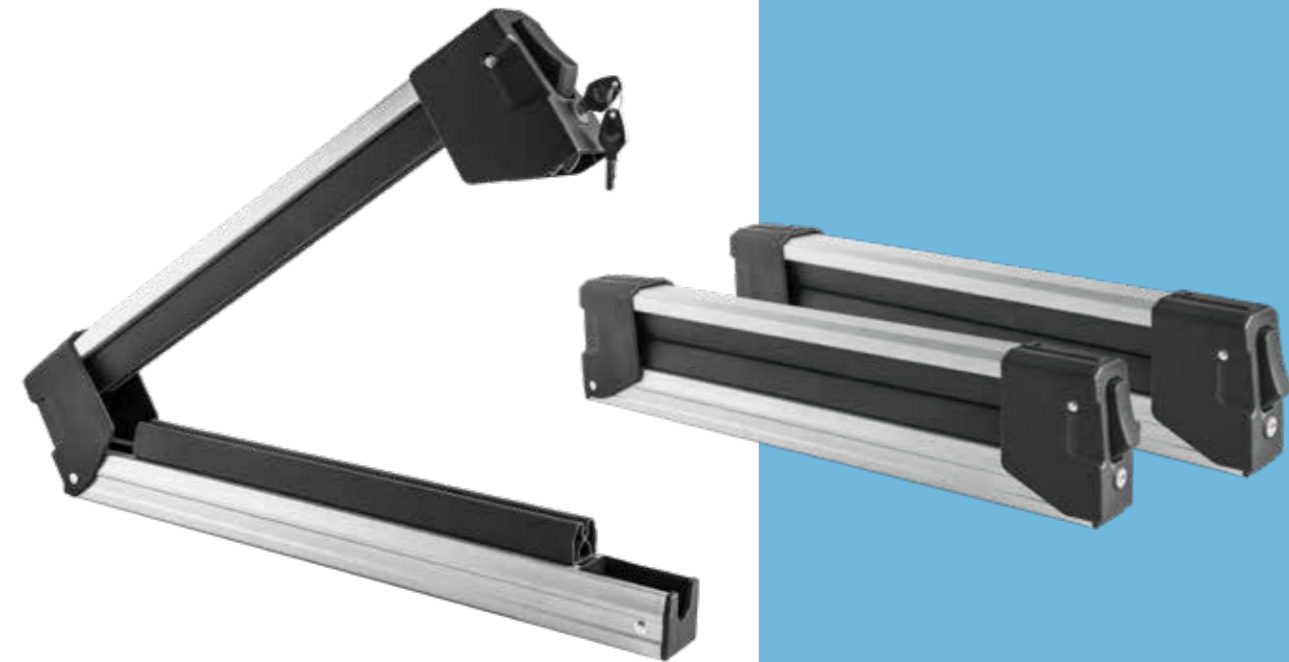

Portasci in alluminio progettato per trasportare fino a 4 paia di sci o 2 snowboard. Fissaggio semplice alle barre tramite t-system e sistema antifurto in dotazione.

Aluminium ski rack for up to 4 pairs of skis, or 2 snowboards. Easy fixing on the roof bars by means of standard T-system and features an anti-theft lock.

Yelo 4NS / Yelo 4NS Black



Yelo 4NS Art.000121600000
Yelo 4NS Black Art.000145900000



Sistema di montaggio rapido interno alle scanalature delle barre tramite viti a "T".

Quick fixing system inside the groove of the bars by means of "T" screws.



Serratura antifurto. Anti-theft lock.



Optional kit 000110300000
Kit opzionale per il montaggio del portasci all'esterno delle barre da tetto. Compatibile con profili larghi max 60 mm / 2.3".
Optional external fixing kit (max 60 mm / 2.3")



ICEBERG



COMPLIANT WITH
DIN 75302:2019

TESTED
CITY CRASH ✓

COMPLIANT WITH
ISO/PAS
11154:2006

Portasci da barra in alluminio per il trasporto di 4 paia di sci o 2 snowboard. Fissaggio alle barre direttamente in cava con sistema tradizionale a "T".

Aluminium ski rack for roof bars suitable for 4 pairs of skis or 2 snowboards. Fastening system to the bars using the T-system.



Sistema di montaggio rapido interno alle scanalature delle barre tramite viti a "T".

Quick fixing system inside the groove of the bars by means of "T" screws.



Serratura antifurto. Anti-theft lock.



Optional kit 000084700000

Kit opzionale per il montaggio del portasci all'esterno delle barre da tetto. Compatibile con profili larghi fino a 80 mm / 3.1".

Optional external fixing kit (max 80 mm / 3.1").

Art.000071800000



ACONCAGUA HIMALAYA



Portasci magnetico leggero, pratico e di facile installazione. Progettato per il trasporto di 3 paia di sci o 2 snowboard, dotato di sistema antifurto.

Magnetic ski rack, lightweight practical and easy to install. Designed to carry 3 pairs of skis or 2 snowboards, equipped with anti-theft lock.



Sistema di montaggio rapido interno alle scanalature delle barre tramite viti a "T".

Quick fixing system inside the groove of the bars by means of "T" screws.



Serratura antifurto. Anti-theft lock.

Art.000008500000



HIMALAYA



Portasci magnetico con serratura antifurto, dal design aerodinamico. Studiato per poter caricare facilmente sia gli sci che i bastoncini, fissando tutto in modo sicuro.

Magnetic ski rack with anti-theft lock with aerodynamic design. Designed to easily load both skis and poles, fixing everything securely.



Vano portasci apribile per posizionare i bastoncini.

Ski housing opens to carry ski poles as well.



Preso di sgancio per smontare rapidamente il portasci.

Release lever for a quick removal of ski rack from the roof.



Serratura antifurto. Anti-theft lock.

Art.000007800000



IGLOO



Portasci magnetico senza antifurto. Leggero, pratico e con fissaggio senza utilizzo di utensili.

Magnetic ski carrier without anti-theft device. Lightweight and easy to mount due to its toolless design.



Preso di sgancio per smontare rapidamente il portasci.

Release lever for a quick removal of ski rack from the roof.

Art.000008100000







L a n e v e
e l a s u a
m e r a v i g l i a

T h e s n o w
a n d i t s
w o n d e r



SCHEMA TECNICA PORTASCI SKI RACKS TECHNICAL DATASHEET

Portasci a confronto Ski racks comparison

Art.	Sistema di montaggio Fixing system				
YELO	T- System External Kit 00012180000 (Optional)	✓	-	6	4
YELO 4NS	T- System External Kit 00011030000 (Optional)	✓	-	4	2
ICEBERG	T- System External Kit 00008470000 (Optional)	✓	-	4	2
ACONCAGUA	Magnetic	✓	-	3	2
HIMALAYA	Magnetic	✓	2	2	-
IGLOO	Magnetic	X	-	2	-

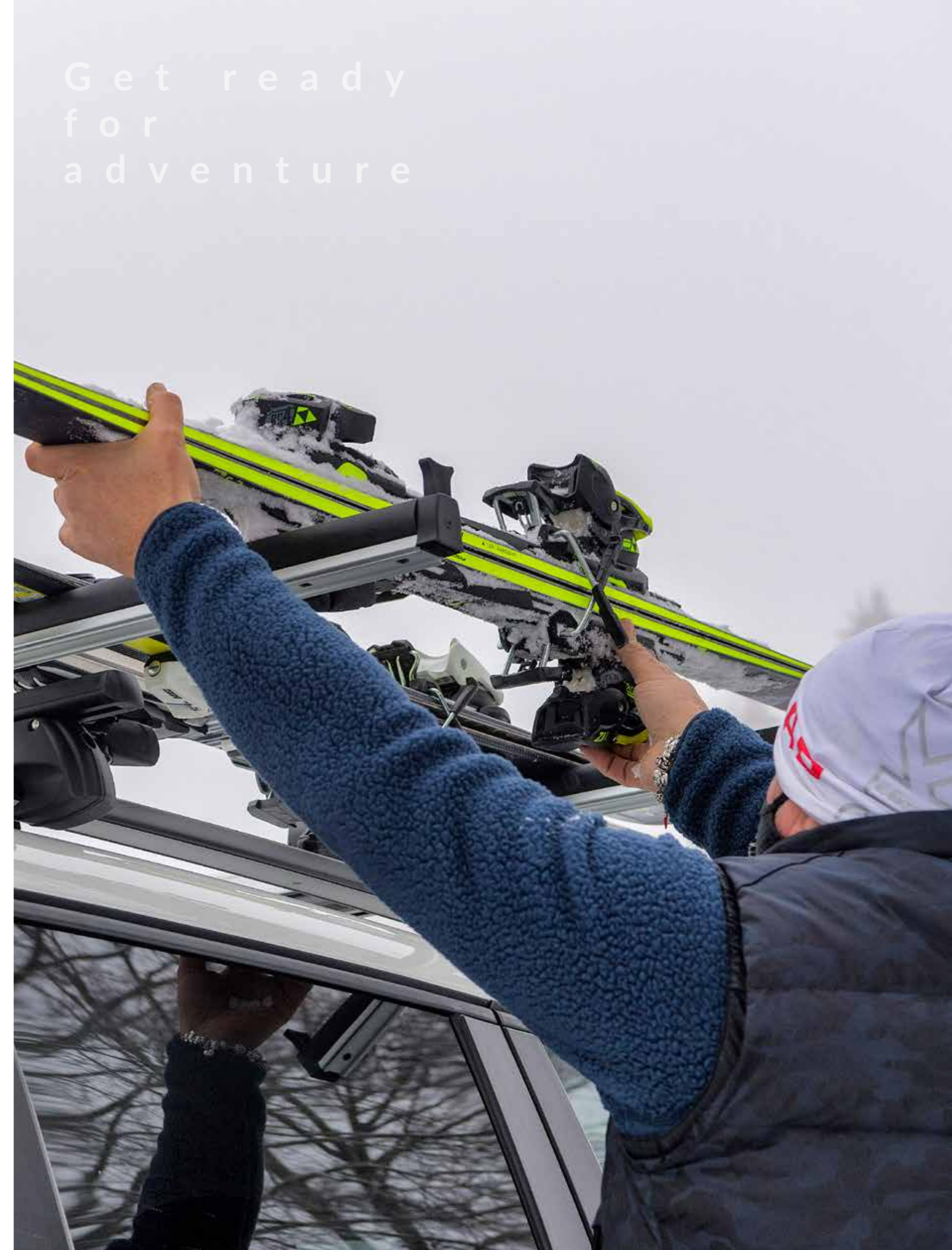

SPORT D'ACQUA

WATER SPORTS

Vivi il mare, i fiumi e le cascate in ogni stagione, in tutte le loro forme e divertiti ad immergerti nelle loro acque insieme a noi.

Experience sea, rivers and waterfalls in every season, in all their forms and enjoy immersing yourself in their waters with us.



WINDSURF PAD



Morbido supporto per il trasporto di windsurf o piccole canoe. Comprende due cinghie robuste per trasportare il carico in sicurezza.

Soft pad to carry windsurfs and canoes.
It includes two heavy-duty straps to secure the cargo.



(LxH)
min: 30x20mm/1x0.8"
max: 80x35mm/3.1x1.4"

NIAGARA



Porta kayak realizzato in acciaio, pratico e richiudibile. Si inclina fino a 100° e può essere sistemato nella posizione desiderata in pochi secondi. Montaggio in cava tramite T-system.

Steel made kayak carrier, extremely easy to handle and foldable. It reclines up to 100° and can be fixed on the roof racks with the T-system bolts.



Sistema di montaggio rapido interno alle scanalature delle barre tramite viti a "T".
Quick fixing system inside the groove of the bars by means of "T" screws.



Richiudibile su se stesso per un agevole trasporto e rimessaggio.
Completely foldable and easy to transport, when not in use.



Optional kit 000110300000

Kit per il montaggio all'esterno delle barre da tetto. Compatibile con profili larghi max 60mm/2.3".

Fixing system external to the roof bars. Compatible with profiles up to 60mm/2.3" wide.

Art.000111800000

Art.000041900000



Let the
fun begin

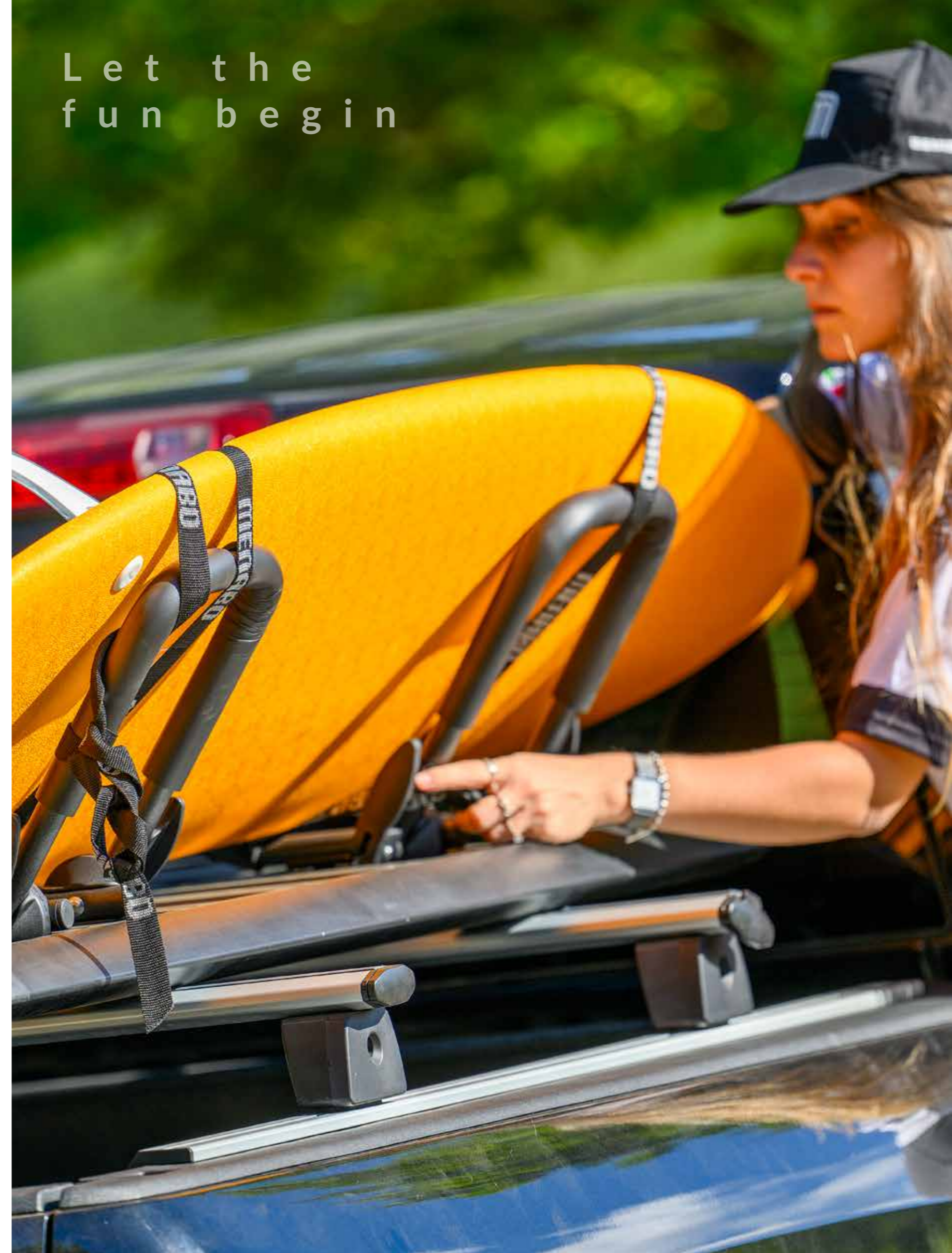

B O R S E E Z A I N I

B A G S A N D
B A C K P A C K S

Vivi il tuo tempo libero al massimo con stile e funzionalità.

Live your free time to the fullest with style and functionality.





ZAINO TREKKING

28 Litri

Lo zaino Trekking, rappresenta al massimo l'idea di viaggio, di maggior contatto con il mondo, di libertà e di indipendenza. Dotato di diversi scomparti, è utile e pratico per i tuoi viaggi grazie anche alla sua capienza da 28 litri! Ottimo anche come bagaglio a mano in aereo.

The Trekking backpack, represents at its best the idea of travel, of greater contact with the world, of freedom and independence. Equipped with several compartments, it is useful and practical for your travels thanks to its 28 liter capacity! Also excellent as cabin luggage on the plane.



ZAINO URBAN

19 Litri

Lo zaino Urban, con la sua capacità da 19 litri e la tasca porta pc, ti accompagnerà in giro per il mondo, dai luoghi più selvaggi alle città più business.

The Urban backpack, with its 19 liter capacity and laptop pocket, will accompany you around the world, from the wildest places to the most business cities.



BORSA SNOW

189 x 29 cm

La nostra borsa Ski-Snow è una sacca portasci perfetta per tenere al sicuro e protetti i tuoi sci prima e dopo esserti divertito sulla neve.

Our Ski-Snow bag is a perfect ski bag to keep your skis safe and protected before and after having fun on the snow.



BORSA TRAVEL

64 Litri

Stile e funzionalità sono le parole d'ordine della nostra borsa Travel. 64 litri di capacità e tanta voglia di mettersi in viaggio, capiente come una valigia, pratica come un borsone!

Style and functionality are the key words of our Travel bag. 64 liters of capacity and a great desire to travel, as spacious as a suitcase, as practical as a duffle bag!



Ovunque tu vada,
noi siamo
con te

Wherever you go,
we are
with you

ORGANIZZAZIONE DEL GARAGE

GARAGE HARDWARE

MENABO
free time on the move



GROUND 2.0
Supporto per bici con innovativo e veloce sistema a leva con basculante. Compatibile anche con E-bike e Fat bike.

Bike stand with Innovative and quick lever system..
Compatible also with E-bikes and Fat bikes.

Art.000129700000



EXTENSION KIT GROUND 2.0 - SNORKEL
Kit d'estensione che consente di trasportare fino a tre supporti Ground 2.0 o Snorkel. Installazione con cinghie su furgoni, furgoncini o piattaforme posteriori dei pickup. Disponibile in due misure.

Extension kit to carry up to 3 Ground 2.0 or Snorkel bike stands.
To be fixed on vans, minivans or pickup rear decks through safety straps. Available in two lengths.

M Art.000140500000
XL Art.000131100000



GARAGE LIFT
Supporto da soffitto con sistema a carrucola per alzare o abbassare le bici o bauli.

Ceiling holder with pulley system to lift or lower bikes or roof boxes.

Art.000082700000



WALL HOOK
Supporto a muro per portabici da gancio traino. Orientabile sia in orizzontale che in verticale.

Wall hook for towbar bike racks. Vertical or horizontal adjustment.

Art.000082600000

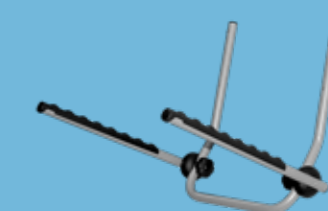

STAR
Supporto da muro per biciclette.

Bike wall hanger.

Art.000020700000



ESPOSITORE PER PORTABICI DA GANCIO PORTER
Espositore per portabici da gancio.

Towbar bike racks display.

ART.000145500000



ESPOSITORE PER BAULI IN FERRO
Espositore in ferro per bauli da tetto.

Iron made display for roof boxes.

ART.000146300000



Always
on your
way



A C C E S S O R I
P E R V E I C O L I
C O M M E R C I A L I

C O M M E R C I A L
V E H I C L E S
A C C E S S O R I E S

Barre da tetto specifiche per veicoli commerciali. Un sistema estremamente versatile in grado di soddisfare le vostre esigenze di trasporto in modo semplice e sicuro.

Specific roof racks for commercial vehicles. An extremely versatile system that fits almost all cargo needs simply and safely.



COMPLIANT WITH
DIN 75302:2019

COMPLIANT WITH
ISO/PAS
11154:2006

PROFILE KIT

Profilo in alluminio leggero e resistente dotato di tre scanalature per il montaggio rapido degli accessori.

Lightweight and sturdy aluminium profile with three slots for quick assembly of accessories.

Gomma anti-fischio.

Anti-whistle rubber profile.

T-System
Optional
art.000110100000

FIXING KIT

Kit di installazione progettato per consentire un montaggio semplice e rapido sul veicolo.

Consultando la nostra lista di applicabilità è possibile selezionare il kit di fissaggio specifico.

Fixing kit designed for a simple and quick installation on almost all commercial vehicles. Check our application list to select the right kit for your vehicle.



FIXING KIT

Kit di installazione composto da quattro elementi: una base universale, una staffa di fissaggio, una copertura protettiva e una cover.

Fixing kit made of four components: a universal base, a steel bracket, an inner protection cover and an outer cover.

OPTIONAL
Art. 000084800000

Kit serratura antifurto
Antitheft lock

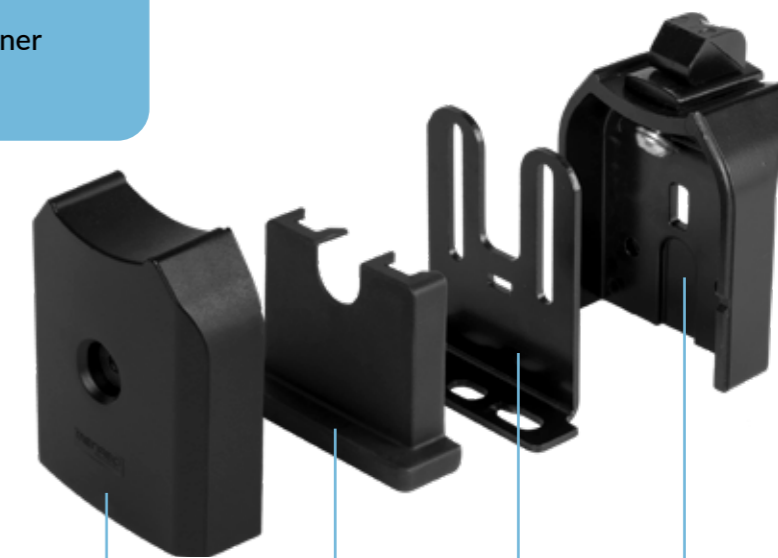

Cover con chiusura a brugola.

Cover with outer key fastening.

Copertura protettiva.

Inner protection cover.

Staffa di fissaggio.

Steel bracket.

Base universale.

Universal base.

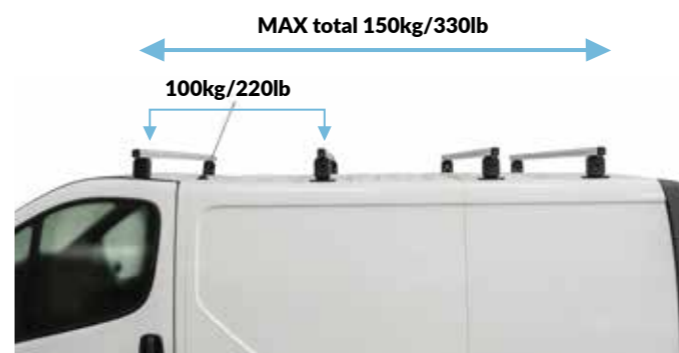

Ogni barra ha una portata massima di 50kg/110lb. A seconda del veicolo, sono installabili fino ad un massimo di sei barre, per una portata totale di 150kg/330lb.

Each bar has a max.load capacity of 50 kg/110lb. Depending on the vehicle, up to six bars can be installed for a total maximum load of 150 kg/330lb.

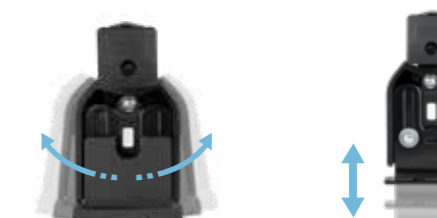

Grazie al suo design è possibile regolare l'inclinazione e l'altezza di ogni barra per trasportare in maniera sicura qualsiasi tipo di carico.

Thanks to its design, it is possible to change the angle and the height of each bar, thus allowing a safe cargo of any kind of load.



TUBO PORTA PROFILATI PROFESSIONAL L3100MM

Porta tubi in alluminio per il trasporto di oggetti lunghi fino a un massimo di 3 metri. Posizionabile sulle barre da tetto sia nello slot superiore che in quelli laterali. Dotato di sportello con serratura antifurto.

Aluminium pipes carrier for the transport of long objects up to 3 mt. It can be placed on the racks both in the upper slot and in the side ones. Equipped with a door with antitheft lock.

Art: 000113400000



RULLO

Supporto per facilitare il carico di oggetti sulle barre facendoli scorrere dal retro del veicolo.

Roll support to facilitate the loading of objects on the bars by pushing them from the back of the vehicle.

RULLO L.1400mm / 55° Art. 000102500000
RULLO L.1800mm / 71° Art. 000102600000



SPONDE LATERALI

Sponde laterali in alluminio leggero e resistente che consentono di mantenere il carico fermo durante la guida. | Conf. 2 pz.

Lightweight and sturdy aluminium side guards to hold the load in place. | Pack: 2 pcs.

SPONDE LATERALI 1400MM SET 2PZ Art. 000102200000
SPONDE LATERALI 1700MM SET 2PZ Art. 000102300000
SPONDE LATERALI 1900MM SET 2PZ Art. 000102400000

SCALETTA PER PROFESSIONAL
Scala resistente e versatile, essenziale per garantire un accesso sicuro e pratico al carico.

Resistant and versatile ladder, essential for ensuring safe and practical access to the load.
Art: 000148800000



DEFLETTORE ANTERIORE PROFESSIONAL

Deflettore anteriore per barre.

Front deflector for roof racks.
Art: 000148700000



CINGHIA LEGACARICO C/CRICK 5M - 1PZ

Cinghia legacarichi con cricchetto.
Conf. 1 pz.

Cargo ratchet belt.
Pack 1 pc.

Art: 000112100000



CINGHIA LEGACARICO C/CRICK + GANCIO 3.3M

Set di due cinghie con gancio a S plastificato (una con cricchetto).

Set of two belts with S-hook (one with ratchet).

Art: 000112200000



GOLFARE SET 2PZ

Occhielli di fissaggio per cinghie.
Conf. 2 pz.

Cargo ring nuts.
Pack 2 pcs.

Art: 000111700000



KIT FERMA CARICO SET 4PZ

Supporto per fissaggio rapido del carico sulle barre.
Conf. 4 pz.

Cargo holder to fix the load on the bars.
Pack 4 pcs.

Art: 000109600000



KIT MONTAGGIO TENDA PER PROFESSIONAL

Kit opzionale per il montaggio delle tende da tetto.

Optional kit for the assembly of roof tents.

Art: 000136400000



KIT DEFLETTORE PROFESSIONAL

Kit deflettori per barre.

Deflectors kit for roof racks.
Art: 000130900000



KIT DEFLETTORI ADESIVI PROFESSIONAL

Kit deflettori adesivi in plastica per barre.

Adhesive deflectors kit for roof racks.
Art: 000134200000





Innovation, Safety, Quality
Made in Italy



Follow us



Via 8 Marzo, 3
42025 Cavriago (RE) - Italy
+39 0522 94 28 40
customercare@flli-menabo.it
www.menabocaraccessories.com